

Değerli dostlarımız,

Firmamız 2001 yılında İstanbul'un Karaköy Perşembepazarı semtinde kurulmuş olup, 20 yılı aşkın süredir ticari faaliyetlerini sürdürmektedir. Her geçen gün artan ürün çeşidiyle, yetişmiş kadrosuyla, yükselen kalitesiyle, oluşan yeni piyasa koşullarına çabuk uyumuyla ve tabiki siz değerli müşterilerimizin katkılarıyla bugünkü durumuna gelmiştir.

Firmamız kendi markası olan "LEO" adı altında geniş ürün çeşidinin yanısıra diğer seçkin dünya markalarının ürünlerini de bünyesinde bulundurmaktadır. Bu ürün yelpazesini genişletirken kaliteden ödün vermemek, uygun fiyat ve satış politikası uygulamak, yurtiçinde her noktaya ulaşmak başlıca amacımız olmuştur.

MCM Hırdavat sizlere geçmişte olduğu gibi bugün ve gelecekte de kaliteli hizmet vermeye devam edecektir.

Saygılarımızla.

MCM Hırdavat İth. İhr. Makina San. ve Tic. Ltd. Şti.

Sütunlu matkaplar		5	Tel fırçalar		38 - 39
Mandrenler		6 - 7	Makaralı kablolar		40
Granit, beton, metal delme testereleeri, pañçlar ve karotlar		8 - 17	Silikon ve epoksi tabancaları		41
Sunta, mermer ve granit kesiciler		18 - 19	Havyalar, mum tabancaları ve sıcak hava tabancaları		42 - 43
El aletleri ve testereleer		20 - 21	Krikolar		44 - 45
Budama testereleeri ve makasları		22 - 23	Bits uçlar		46 - 50
Çektirmeler, demir ve kablo makasları, mini işkenceler ve sac makasları		24 - 27	İş güvenliđi ayakkabıları		51
Maket bıçakları		28 - 29	Kaynakçı ekipmanları		52
Su terazileri, cetveller ve sentiller		30 - 31	Kaynak makinaları		53 - 61
Lazerli ölçüm cihazları		32 - 33	Paftalar ve bakır boru kesiciler		62 - 66
Kumpaslar, mikrometreleer, komparatör saatleri ve gönyeler		34 - 37	PVC boru kesiciler ve maşalı boru anahtarları		67 - 69

Yağlama ekipmanları ve gres pompaları	70 - 73
Cam kesme elmasları	74 - 75
Vantuzlar	76 - 77
Eğeler	78 - 79
Testere ağızları	80
Beton matkap uçları	81
El aletleri	82 - 87
Boru kaynak setleri	88
Kesici taşlar, HSS ve SDS matkap uçları, Ağaç matkap uçları	89 - 99
SDS keski ve murçlar	100
Havşa uçları	101

Dekupaj ağızları ve tilki kuyrukları HSS alüminyum freze uçları Torna aynaları ve tutucular	102 - 107
HSS kılavuz grubu HSS pafta grubu HSS freze grubu ve Karbür kalıpcı freze grubu	108 - 119
Kaynak hortumları, spiral hortumlar ve bağlantı elemanları	120 - 123
Kaynak setleri ve boya tabancaları	124 - 125
Takım çantaları	126 - 129
Dezenfekte makinası, epoksi kartuşlar ve kamp ocakları	130 - 132
ROX WOOD hobi ürünleri Ağaç işleme aletleri ve kimyasal dübelleri	133 - 139
Boya karıştırıcılar, seramik kesme makinaları, ve bahçe hortumları	140 - 143
RED HIT matkap uçları çivi çakma tabancası zimba ve çiviler Dübelleri	144 - 151
Matkaplar, taşlama, polisaj manyetik matkap ve uçları	152 - 153
Rapid ürünleri Zimba ve silikon tabancaları	154 - 159

LEO

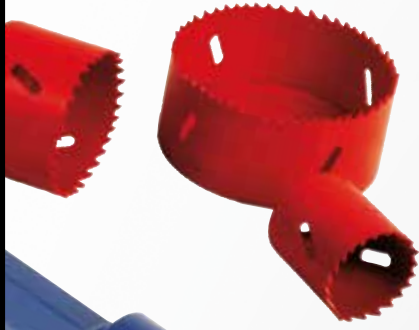

Sütunlu Matkaplar



13 mm.
KISA BOY
180.00 USD



16 mm.
ORTA BOY
370.00 USD



16 mm.
UZUN BOY
470.00 USD

Teknik Özellikler

	13 mm Kısa boy	16 mm Orta boy	16 mm Uzun boy
Motor	220 V/50 Hz/350 W	220 V/50 Hz/550 W	220 V/50 Hz/550 W
Döner tabla	208 mm.	252 mm.	305 mm.
Maks. delme kapasitesi	13 mm.	16 mm.	16 mm.
Mandren kapasitesi	13 mm.	16 mm.	16 mm.
Mil hareketi	50 mm.	60 mm.	80 mm.
Devir sayısı	5	12	12
Devir hızı	500 - 2500	230 - 2470	230 - 2470
Genel yükseklik	580 mm.	840 mm.	1565 mm.
Ölçüler	465 x 235 x 345	690 x 425 x 255	1205 x 425 x 200
Ağırlık	17 / 19 Kg.	36 / 38 Kg.	55 / 59 Kg.



1

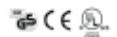



Anahtarlı Mandrenler



BOYUTLAR		FİYAT
1.5 - 10 mm 1/2 - 20" dişi	100	3.05 USD
1.5 - 10 mm 3/8 - 24" dişi	100	3.05 USD
1.5 - 13 mm 1/2 - 20" dişi	50	3.65 USD
1.5 - 13 mm 3/8 - 24" dişi	50	3.65 USD
1.5 - 13 mm B16 konik	50	6,00 USD
3.0 - 16 mm 1/2 - 20" dişi	30	9,50 USD
3.0 - 16 mm B18 konik	30	10,50 USD
5.0 - 20 mm B22 konik	20	18,00 USD

Mandren Anahtarları



BOYUTLAR			FİYAT
10 - 13 mm	100	500	0.53 USD
16 mm	60	300	0.83 USD
20 mm	20	300	1.25 USD

Anahtarsız Otomatik Sıkmalı Mandrenler



BOYUTLAR		FİYAT
0.8 - 10 mm 1/2 - 20" dişi	50	3.00 USD
0.8 - 10 mm 3/8 - 24" dişi	50	3.00 USD
1.5 - 13 mm 1/2 - 20" dişi	50	3.80 USD
1.5 - 13 mm 3/8 - 24" dişi	50	3.80 USD

SDS Mandren Adaptörü



BOYUTLAR		FİYAT
1/2"x20 mm	500	0.90 USD
3/8"x24 mm	250	0.90 USD

Metal Gövdeli, Kilitli Otomatik Mandren



BOYUTLAR		FİYAT
1,5-10 mm 3/8-24	50	8.45 USD
2,0-13 mm 1/2-20	50	10.50 USD

Supra Mandrenler

YENİ



BOYUTLAR		FİYAT
1,0 - 13 mm B 16	20	25.00 USD
1,0 - 16 mm B 18	20	32.00 USD
5,0 - 20 mm B 22	20	46.00 USD

Şarjlı Mini Matkap Mandreni

YENİ



BOYUTLAR		FİYAT
4 mm	100	5.10 USD
6 mm	100	5.70 USD

Bi-Metal Delme Testereleri

Uzunluk: 42 mm

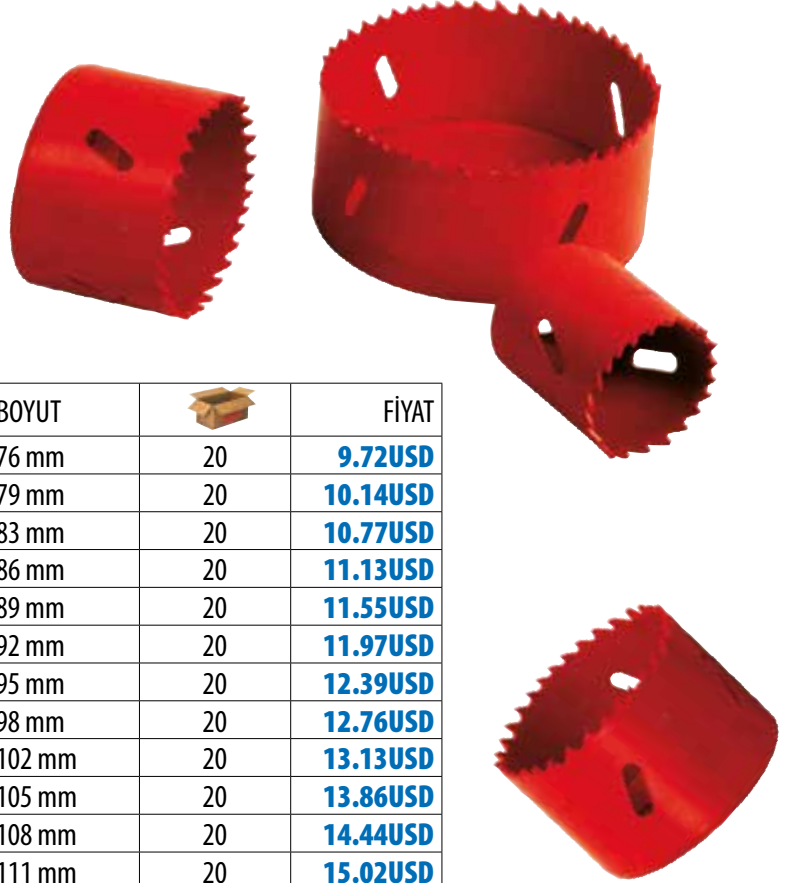

BOYUT		FİYAT
14 mm	200	2.31USD
16 mm	200	2.63USD
17 mm	200	2.68USD
19 mm	200	3.05USD
20 mm	200	3.15USD
22 mm	200	3.36USD
24 mm	200	3.52USD
25 mm	200	3.73USD
28 mm	100	3.89USD
30 mm	100	4.10USD
32 mm	100	4.41USD
35 mm	100	4.73USD
38 mm	100	5.04USD
40 mm	100	5.36USD
41 mm	100	5.41USD
44 mm	100	5.46USD
48 mm	100	6.25USD
51 mm	100	6.62USD
54 mm	50	7.14USD
57 mm	50	7.35USD
60 mm	50	7.72USD
65 mm	50	8.40USD
66 mm	50	8.72USD
68 mm	50	8.88USD
70 mm	50	8.98USD
73 mm	20	9.24USD

BOYUT		FİYAT
76 mm	20	9.72USD
79 mm	20	10.14USD
83 mm	20	10.77USD
86 mm	20	11.13USD
89 mm	20	11.55USD
92 mm	20	11.97USD
95 mm	20	12.39USD
98 mm	20	12.76USD
102 mm	20	13.13USD
105 mm	20	13.86USD
108 mm	20	14.44USD
111 mm	20	15.02USD
114 mm	20	15.60USD
121 mm	20	16.17USD
127 mm	10	16.80USD
133 mm	10	17.85USD
140 mm	10	18.48USD
146 mm	10	19.65USD
152 mm	10	20.80USD
160 mm	10	22.05USD
165 mm	10	23.10USD
168 mm	10	23.73USD
178 mm	10	24.90USD
200 mm	10	26.67USD
210 mm	10	28.88USD
220 mm	10	30.61USD

Bi-Metal Delme Testeresi Adaptörleri



MODEL	BOYUT		FİYAT
002	14 - 30 mm	100	3.00 USD
006	32 - 210 mm	100	5.60 USD
009	SDS 14 - 30 mm	100	5.00 USD
010	SDS 32 - 210 mm	100	6.80 USD

Bi-Metal Delme Testere Seti 9 Parçalı



19 mm, 22 mm, 29 mm,
38 mm, 44 mm, 57 mm

34.00 USD



10

Bi-Metal Delme Testere Seti 13 Parçalı



19 mm, 22 mm, 29 mm,
35 mm, 38 mm, 44 mm,
51 mm, 57 mm, 64 mm

50.00 USD



10

Ağaç Buat Seti 8 Parçalı



64 mm, 76 mm, 89 mm,
102 mm, 127 mm

11.50 USD



20

Ağaç Buat Seti 11 Parça



19 mm, 22 mm, 29 mm,
32 mm, 38 mm, 44 mm,
51 mm, 64 mm

12.00 USD



20

Ağaç Buat Seti 16 Parça



19 mm, 22 mm, 29 mm,
32 mm, 38 mm, 44 mm,
51 mm, 64 mm, 76 mm,
89 mm, 102 mm, 127 mm

16.50 USD



20

Elmas Panç Seti 8 Parça



33 mm, 53 mm,
67 mm,
73 mm, 83 mm

35.00 USD



6



TCT Metal Delme Pa

YENİ



Uzunluk 75 mm



KOD	EBAT			FIYAT
4700	16 mm	10	300	2.55USD
4701	18 mm	10	340	2.75USD
4702	19 mm	10	340	3.00USD
4703	20 mm	10	340	3.10USD
4704	22 mm	10	300	3.37USD
4705	25 mm	10	250	3.70USD
4706	28 mm	10	300	4.20USD
4707	30 mm	10	180	4.55USD
4708	32 mm	10	180	4.70USD
4709	35 mm	10	180	5.25USD
4710	38 mm	10	120	5.90USD
4711	40 mm	10	120	6.20USD
4712	44 mm	6	72	6.75USD
4713	48 mm	6	72	7.45USD
4714	50 mm	6	72	7.55USD
4715	54 mm	6	72	8.35USD
4716	60 mm	6	72	8.95USD
4717	65 mm	4	48	9.75USD
4718	70 mm	4	48	10.60USD
4719	75 mm	4	48	12.57USD
4720	80 mm	1	27	14.25USD
4721	85 mm	1	27	15.85USD
4722	90 mm	1	27	16.65USD
4723	95 mm	1	27	18.95USD
4724	100 mm	1	36	28.75USD
4725	110 mm	1	24	29.40USD
4726	120 mm	1	24	31.55USD

Plastik kutulu

Duvar Delme Paçları



ÜRÜN	BOYUTLAR		FİYAT
30 mm	30x170 mm	10	30.00USD
40 mm	40x170 mm	10	33.00USD
45 mm	45x170 mm	10	36.50USD
50 mm	50x170 mm	10	38.50USD
60 mm	60x170 mm	10	41.50USD
65 mm	65x170 mm	10	44.00USD
70 mm	70x170 mm	10	47.00USD
80 mm	80x170 mm	10	49.50USD
90 mm	90x170 mm	10	55.00USD
100 mm	100x170 mm	10	60.00USD
110 mm	110x170 mm	6	65.00USD
120 mm	120x170 mm	6	70.00USD
125 mm	125x170 mm	6	73.00USD
130 mm	130x170 mm	6	76.00USD
140 mm	140x170 mm	6	80.00USD
150 mm	150x170 mm	6	88.00USD

Duvar Delme SDS PLUS Paç Adaptörleri



ÜRÜN	BOYUTLAR		FİYAT
SDS PLUS Paç Adaptörü	10x115 mm	25	7.00 USD
SDS PLUS Paç Adaptörü	10x240 mm	25	11.00 USD

Duvar Delme SDS MAX Paç Adaptörleri



ÜRÜN	BOYUTLAR		FİYAT
SDS MAX Paç Adaptörü	18x155 mm	25	11.00 USD
SDS MAX Paç Adaptörü	18x240 mm	20	17.00 USD

Duvar Delme Paç Adaptörleri Merkezleme Ucu



ÜRÜN	BOYUTLAR		FİYAT
Merkezleme Ucu	10x200 mm	200	2.70 USD

Elmaslı Beton Delme Pançları

YENİ



ÜRÜN	BOYUTLAR		FİYAT
30 mm	30x72 mm	50	5.19 USD
35 mm	35x72 mm	50	5.67 USD
40 mm	40x72 mm	50	6.10 USD
45 mm	40x72 mm	50	6.20 USD
50 mm	50x72 mm	50	7.00 USD
55 mm	55x72 mm	50	7.50 USD
60 mm	60x72 mm	50	8.00 USD
65 mm	65x72 mm	50	8.50 USD
70 mm	70x72 mm	40	9.00 USD
75 mm	75x72 mm	40	9.50 USD
80 mm	80x72 mm	40	10.50 USD
90 mm	90x72 mm	25	14.00 USD
100 mm	100x72 mm	20	17.50 USD
110 mm	110x72 mm	20	20.00 USD
120 mm	120x72 mm	10	23.50 USD
125 mm	125x72 mm	10	27.00 USD

Elmaslı Beton Delme
SDS PLUS Panç Adaptörleri

ÜRÜN	BOYUTLAR		FİYAT
SDS PLUS Panç Adaptörü	110 mm	100	4.50 USD
SDS PLUS Panç Adaptörü	250 mm	50	6.50 USD
SDS PLUS Panç Adaptörü	350 mm	25	7.80 USD

Elmaslı Beton Delme
SDS MAX Panç Adaptörleri

ÜRÜN	BOYUTLAR		FİYAT
SDS MAX Panç Adaptörü	250 mm	50	8.00 USD
SDS MAX Panç Adaptörü	350 mm	25	9.00 USD

Kademeli Sac Delme Pançları 4 mm



TİN KAPLAMA

BOYUTLAR			FİYAT
HSS 4 - 12 mm	10	90	3.00 USD
HSS 4 - 20 mm	10	90	4.40 USD
HSS 4 - 30 mm	6	54	8.00 USD
HSS 4 - 32 mm	6	54	8.80 USD
HSS 4 - 39 mm	5	45	16.50 USD

Blister ambalajlı

Kademeli Sac Delme Takımları



Blister ambalajlı

TİN KAPLAMA
HSS : 4 - 12 mm
HSS : 4 - 20 mm
HSS : 4 - 32 mm

17.00 USD



40



TİN KAPLAMA
HSS : 4 - 12 mm
HSS : 4 - 20 mm
HSS : 4 - 32 mm
METAL KUTULU
17.80 USD



40



TİN KAPLAMA
HSS : 4 - 12 mm
HSS : 6 - 20 mm
HSS : 6 - 30 mm
TAHTA KUTULU
27.00 USD



20

Kademeli Sac Delme Pançları 6 mm



TİN KAPLAMA

BOYUTLAR			FİYAT
HSS 6 - 30 mm	8	40	19.00 USD
HSS 6 - 52 mm	10	40	46.00 USD

Kademeli Sac Delme Takımı 6 Parçalı

20.00 USD



20



Adaptörlü Mermer Pançlar



BOYUTLAR		FİYAT
16 mm	100	4.60 USD
18 mm	100	5.05 USD
20 mm	100	5.52 USD
22 mm	100	6.10 USD
25 mm	100	6.70 USD
30 mm	100	7.95 USD
35 mm	50	9.20 USD
40 mm	50	10.50 USD

Elmaslı Granit Delme Pançları (Matkapla uygulanır)



ÜRÜN	BOYUTLAR		FİYAT
18 mm hex	18x80 mm	100	12.80 USD
20 mm hex	20x80 mm	100	13.60 USD
22 mm hex	22x80 mm	100	14.40 USD
25 mm hex	25x80 mm	100	15.20 USD



Elmaslı Granit Delme Pançları (Taşlamada uygulanır)



ÜRÜN	BOYUTLAR		FİYAT
20 mm m14	20x80 mm	100	13.60 USD
22 mm m14	22x80 mm	100	14.40 USD
25 mm m14	25x80 mm	100	15.20 USD

Mermer Granit Delme (Kuru Kesim) Hex Leo Altın Seri

YENİ



ÜRÜN	BOYUTLAR		FİYAT
Leo Altın Seri	6 mm	10	11.50 USD
Leo Altın Seri	8 mm	10	12.10 USD
Leo Altın Seri	10 mm	10	12.65 USD
Leo Altın Seri	12 mm	10	13.20 USD
Leo Altın Seri	14 mm	10	14.30 USD
Leo Altın Seri	16 mm	10	14.85 USD



Mermer Granit Delme (Kuru Kesim) M 14 Leo Altın Seri

YENİ



ÜRÜN	BOYUTLAR		FİYAT
Leo Altın Seri	12 mm	10	12.15 USD
Leo Altın Seri	14 mm	10	12.50 USD
Leo Altın Seri	16 mm	10	13.10 USD
Leo Altın Seri	18 mm	10	14.35 USD
Leo Altın Seri	20 mm	10	16.20 USD
Leo Altın Seri	22 mm	10	17.60 USD
Leo Altın Seri	25 mm	10	20.80 USD
Leo Altın Seri	30 mm	10	26.00 USD
Leo Altın Seri	35 mm	10	28.10 USD
Leo Altın Seri	38 mm	10	31.20 USD
Leo Altın Seri	40 mm	10	33.40 USD
Leo Altın Seri	45 mm	10	36.40 USD
Leo Altın Seri	50 mm	10	41.00 USD
Leo Altın Seri	55 mm	10	45.00 USD
Leo Altın Seri	63 mm	10	49.40 USD
Leo Altın Seri	65 mm	10	54.70 USD



Elmaslı Granit, Mermer Delme Pançları M 14

Sadece sulu kullanımda değil,
kuru kullanım için de uygundur.



ÇAP	FİYAT
20 mm	20.00 USD
25 mm	23.00 USD
30 mm	24.00 USD
33 mm	26.00 USD
35 mm	29.00 USD
40 mm	31.00 USD
45 mm	36.00 USD

ÇAP	FİYAT
50 mm	40.00 USD
55 mm	42.00 USD
60 mm	45.00 USD
65 mm	46.50 USD
70 mm	48.00 USD
75 mm	50.00 USD
80 mm	54.00 USD

Yüzey Silmeler ve Temizlemeler



ÇAP	AÇIKLAMA	FİYAT
115 mm	Tek sıralı	31.00 USD
115 mm	Çift sıralı	44.00 USD
150 mm	Tek sıralı	49.00 USD
150 mm	Çift sıralı	60.00 USD
180 mm	Tek sıralı	64.00 USD
180 mm	Çift sıralı	90.00 USD

Mozaik Silme Makinaları İçin



Silim Tablası	215.00 USD
Pençe Takozu	57.00 USD
Elmas Takozu	59.00 USD

Karot Uçları Lazer Kaynak



ÇAP	SOKET ADEDİ	FİYAT
20 mm	3	29.50 USD
25 mm	3	30.00 USD
28 mm	3	32.50 USD
30 mm	3	34.00 USD
34 mm	3	35.00 USD
40 mm	3	37.00 USD
50 mm	4	42.50 USD
60 mm	5	52.00 USD
70 mm	6	58.50 USD
80 mm	7	67.00 USD
90 mm	8	74.50 USD
100 mm	9	81.50 USD
110 mm	9	85.50 USD

ÇAP	SOKET ADEDİ	FİYAT
120 mm	10	98.00 USD
130 mm	11	109.00 USD
140 mm	12	118.00 USD
150 mm	13	130.00 USD
160 mm	14	141.00 USD
180 mm	15	182.00 USD
200 mm	16	194.00 USD
220 mm	16	210.00 USD
250 mm	18	241.00 USD
300 mm	20	275.00 USD
350 mm	22	333.00 USD
400 mm	22	385.00 USD
450 mm	24	460.00 USD

Karot Uzatmalar



UZUNLUK	FİYAT
15 cm	26.50 USD
20 cm	33.50 USD
30 cm	51.00 USD
40 cm	69.00 USD
50 cm	89.00 USD

Beton Kesme Testeresi

LAZER KAYNAKLI

Sulu kullanım daha verimli ve daha uzun ömürlüdür



DİŞ	ÇAP	FİYAT
18 mm	300 mm	80.00 USD
21 mm	350 mm	94.00 USD
24 mm	400 mm	110.00 USD
26 mm	450 mm	152.00 USD
30 mm	500 mm	196.00 USD
36 mm	600 mm	275.00 USD

Asfalt Kesme Testeresi

LAZER KAYNAKLI

Sulu kullanım daha verimli ve daha uzun ömürlüdür



DİŞ	ÇAP	FİYAT
18 mm	300 mm	89.00 USD
21 mm	350 mm	108.00 USD
24 mm	400 mm	132.00 USD
26 mm	450 mm	177.00 USD
30 mm	500 mm	225.00 USD
36 mm	600 mm	300.00 USD

Sunta Kesme Testeresi (Elmaslı)
115 mm
40T x 22,23 mm



3.50 USD



Sunta Kesme Testeresi (Elmaslı)
180 mm
40T x 22,23 mm



5.75 USD



Sunta Kesme Testeresi (Elmaslı)



AÇIKLAMA	FIYAT
160 mm Elmas Sunta Testere 40T x 22,23 mm	5.50 USD
160 mm Elmas Sunta Testere 40T x 30,00 mm	5.50 USD
180 mm Elmas Sunta Testere 40T x 30,00 mm	5.75 USD
185 mm Elmas Sunta Testere 40T x 30,00 mm	6.50 USD
190 mm Elmas Sunta Testere 40T x 30,00 mm	7.25 USD
210 mm Elmas Sunta Testere 40T x 30,00 mm	8.50 USD
230 mm Elmas Sunta Testere 40T x 30,00 mm	11.25 USD
250 mm Elmas Sunta Testere 40T x 30,00 mm	13.75 USD
300 mm Elmas Sunta Testere 40T x 30,00 mm	24.50 USD
350 mm Elmas Sunta Testere 40T x 30,00 mm	30.00 USD
400 mm Elmas Sunta Testere 40T x 30,00 mm	35.00 USD

Sürekli Turbo Elmas Mermer Granit Kesici



YENİ

EBAT	MCM		FİYAT
115 mm	10	100	1.85 USD
180 mm	1	50	4.90 USD
230 mm	1	25	7.75 USD

Turbo Elmas Mermer Granit Kesici



EBAT	MCM		FİYAT
115 mm	10	100	2.20 USD
180 mm	1	50	5.00 USD
230 mm	1	25	8.35 USD

Turbo Seramik Fayans Kesici (İnce Kesim)



EBAT	MCM		FİYAT
115x1,2 mm	1	100	6.50 USD
125x1,3 mm	1	100	7.50 USD
180x1,6 mm	1	40	12.00 USD

Turbo Seramik Fayans Kesici (Hassas Kesim)



EBAT	MCM		FİYAT
115x1,2 mm	1	100	7.10 USD

Soketli Elmas Beton Mermer Kesici



EBAT	MCM		FİYAT
115 mm	10	100	2.00 USD
180 mm	1	50	4.80 USD
230 mm	1	25	8.00 USD

**Kıl Testere Kolu
Ağaç Saplı**



10.00 USD



**Kıl Testere Kolu Ayarlı
Ağaç Saplı**



11.00 USD



Metal Kıl Testere 150 mm



4.50 USD

**Tahta Saplı Kıl Testere
(5 Yedekli)**



6.00 USD

Kıl Testere Seti



YENİ

7.50 USD



**Kıl Testere Yedeği
(6 Adet)**



4.00 USD

Tilki Kuyruğu Testere Ergonomik Saplı 165 mm



YENİ

MODEL	BOYUTLAR	MCM	Box	FİYAT
165	165 mm	12	48	6.50 USD

Budama Testeresi 2027
Kurt Dişli

YENİ

MODEL	BOYUTLAR	Box	FİYAT
2027	300 mm	36	5.00 USD

Alçıpan Testere 150 mm



YENİ

MODEL	BOYUTLAR	MCM	Box	FİYAT
MK 4600	150 mm	6	48	6.10 USD

Gaz Beton Testeresi 550 mm



YENİ

MODEL	BOYUTLAR	MCM	Box	FİYAT
MK 4610	550 mm	6	24	21.00 USD

Demir Testere Kolu Metal 300 mm



YENİ

MODEL	BOYUTLAR	MCM	Box	FİYAT
MK 4693	300 mm	12	48	3.75 USD

Kıl Testere Kolu 150 mm
(Yedek Ağızlı)

» Yedek Ağızlı

YENİ

MODEL	BOYUTLAR	MCM	Box	FİYAT
MK 4698	150 mm	12	144	1.75 USD

Budama Testeresi Kılıflı 300 mm



YENİ

KOD	ÖLÇÜ	MCM		FİYAT
MK4534	300 mm	12	48	5.00 USD

Budama Testeresi PVC Saplı Oval 330 mm



YENİ

KOD	ÖLÇÜ	MCM		FİYAT
MK4536	330 mm	12	48	6.15 USD

Budama Testeresi Katlanır 180 mm



YENİ

KOD	ÖLÇÜ	MCM		FİYAT
MK4548	180 mm	12	96	5.10 USD

Çim Biçme Makası



YENİ

KOD	ÖLÇÜ	MCM		FİYAT
MK4550	Çim biçme	6	24	10.75 USD

Çim Biçme Makası Teleskobik



YENİ

KOD	ÖLÇÜ	MCM		FİYAT
MK4552	Çim biçme	6	24	13.75 USD

Budama Testeresi Kartal Sap Takmalı 380 mm



YENİ

KOD	ÖLÇÜ	MCM	Box	FİYAT
MK4547	380 mm	6	48	10.00 USD

Dal Budama Makası



YENİ

KOD	ÖLÇÜ	MCM	Box	FİYAT
MK4560	5 cm ağız	6	12	21.50 USD

Dal Budama Makası Teleskobik



YENİ

KOD	ÖLÇÜ	MCM	Box	FİYAT
MK4562	5 cm ağız	6	12	30.00 USD

Tepe Makas Teleskobik



YENİ

KOD	ÖLÇÜ	MCM	Box	FİYAT
MK4570	Metal 2.80 cm	1	6	32.00 USD
MK4572	Alüm. 2.80 cm	1	6	36.00 USD

Sulama Tabancası Çelik



YENİ

KOD	ÖLÇÜ	MCM	Box	FİYAT
MK1488	Çelik	12	48	9.00 USD

Çektirme 2 Ayaklı, Düz Raylı



ÜRÜN	BOYUTLAR		FİYAT
3"	80x100 mm	28	20.70 USD
4"	120x100 mm	28	26.45 USD
6"	150x150 mm	9	47.15 USD
8"	200x150 mm	9	56.35 USD
10"	250x200 mm	4	94.30 USD

Çektirme 3 Ayaklı, Mafsallı



ÜRÜN	BOYUTLAR		FİYAT
3"	15x80 mm	20	9.80 USD
4"	20x120 mm	20	15.25 USD
6"	25x160 mm	12	22.25 USD
8"	30x210 mm	10	39.10 USD
10"	40x260 mm	6	65.00 USD

Kablo Makası CRV



ÜRÜN	BOYUTLAR	KESME KAPASİTESİ		FİYAT
450 mm	18"	22 mm	10	23.00 USD
600 mm	24"	26 mm	8	33.35 USD
800 mm	32"	40 mm	5	53.50 USD
900 mm	36"	50 mm	4	59.25 USD

Kupbulon Makası CRV
(Demir Makası)

ÜRÜN	BOYUTLAR	KESME KAPASİTESİ		FİYAT
450 mm	18"	2 - 6 mm	20	23.00 USD
600 mm	24"	2 - 8 mm	10	30.50 USD
800 mm	30"	2 - 10 mm	5	48.30 USD
900 mm	36"	3 - 12 mm	5	57.50 USD

Boru Mengenesi



ÜRÜN	BOYUTLAR		FİYAT
1"	10x60 mm	6	34.50 USD
2"	10x90 mm	4	39.10 USD
3"	15x115 mm	2	63.25 USD

G Tipi İşkence

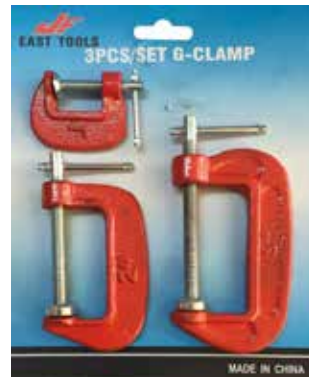

ÜRÜN	BOYUTLAR		FİYAT
G tipi işkence	3"	48	6.90 USD
G tipi işkence	4"	36	9.20 USD
G tipi işkence	5"	24	11.50 USD

G Tipi İşkence Seti
3'lü**6.90 USD** 72

Tenekeci Makası (Alman Tipi)



ÜRÜN	BOYUTLAR		FİYAT
Alman tipi	10"	60	11.00 USD
Alman tipi	12"	30	13.20 USD

Tenekeci Makası



ÜRÜN	BOYUTLAR		FİYAT
Tenekeci makası	10" Sol	40	10.00 USD
Tenekeci makası	10" Düz	40	10.00 USD

Sac Kesme Makasları



MODEL		FİYAT
Sağ 10" Kırmızı	50	8.00 USD

10 luk kutular halinde.

Kuyumcu Makası



ÜRÜN	BOYUTLAR		FİYAT
Kuyumcu makası	7"	60	7.00 USD

Tel Makası CRV



ÜRÜN	BOYUTLAR		FİYAT
Tel makası	8"	60	8.00 USD

PVC Boru Kesici Yarı Otomatik



ÜRÜN	BOYUTLAR		FİYAT
PVC Makası	42 mm	48	7.00 USD

Maket Bıçağı SX-82

Plastik
18 mm

YENİ

0.85 USD



24 lük Kutularda

288

Maket Bıçağı SX-9

Plastik
18 mm

0.40 USD



720

Cam Kazıma Bıçağı SX-53

Plastik
24 lük Kutularda

0.55 USD



720

Maket Bıçağı SX-06
(İş Güvenliği)

YENİ

12 lik Kutularda

2.95 USD



288

Maket Bıçağı SX-95

18 mm.
Metal

1.00 USD

24 lük Kutularda

288

Maket Bıçağı SX-98



18 mm.
Metal



1.30 USD

24 lük Kutularda



288

Maket Bıçağı SX-96



9 mm.
Metal



1.40 USD

24 lük Kutularda



288

Maket Bıçağı Yedeği
SX-18T-100

Bıçak kalınlığı: 0.5 mm



18 mm
Düz Kırlabilir
100 lük Kutularda

8.75 USD/kutu



40 kutu

Maket Bıçağı Yedeği
SX-09 T-100

Bıçak kalınlığı: 0.4 mm



YENİ



9 mm
Düz Kırlabilir
100 lük Kutularda

6.00 USD/kutu



80 kutu

Maket Bıçağı Yedeği
SX-11 T-100

Bıçak kalınlığı: 0.6 mm



YENİ



19 mm
İş güvenlik maket bıçakları için uygundur.

10.00 USD/kutu



10 kutu

Su Terazisi 107 Modeli



MODEL	BOYUT	ÖZELLİK		FİYAT
107	30 cm.	3 gözlü	30	3.10 USD
107	40 cm.	3 gözlü	30	3.50 USD
107	50 cm.	3 gözlü	30	4.10 USD
107	60 cm.	3 gözlü	30	4.70 USD
107	80 cm.	3 gözlü	20	5.60 USD
107	100 cm.	3 gözlü	20	6.40 USD
107	120 cm.	3 gözlü	20	7.60 USD

Su Terazisi Mıknatıslı 96 Modeli



MODEL	BOYUT	ÖZELLİK		FİYAT
96	40 cm.	3 gözlü	30	6.60 USD
96	50 cm.	3 gözlü	30	7.15 USD
96	60 cm.	3 gözlü	30	8.25 USD
96	80 cm.	3 gözlü	20	9.60 USD

VOLA Döküm Su Terazisi 248 Modeli

YENİ



MODEL	BOYUT		FİYAT
Döküm, 3 gözlü	30 cm	10	17.40 EURO
Döküm, 3 gözlü	40 cm	10	19.70 EURO
Döküm, 3 gözlü	50 cm	10	21.60 EURO
Döküm, 3 gözlü	60 cm	10	25.50 EURO
Döküm, 3 gözlü	80 cm	10	30.00 EURO

Çizim İpi ve Boyası



MODEL		FİYAT
30 metre ve 120 gr mavi boyalı	48	3.50 USD

Çift Taraflı Çelik Cetveller



BOYUTLAR		FİYAT
150 x 20 mm	600	0.65 USD
300 x 25 mm	300	1.15 USD
500 x 30 mm	300	2.55 USD
1000 x 35 mm	120	6.35 USD

12 lik kutular halinde.

Sentil Filler Çakısı



KOD	BOYUTLAR		FİYAT
1410	0,05 - 1x100 mm (20 yapraklı)	100	2.25 USD
1411	0,05 - 1x200 mm (20 yapraklı)	100	4.35 USD

Plastik şeffaf poşettedir.

Diş Tarağı (Metrik ve Inch)



KOD	BOYUTLAR		FİYAT
1420	52 Parçalı Metrik ve Inch kombine set	100	8.50 USD

Plastik şeffaf poşettedir.

Radius Mastarı



KOD	BOYUTLAR		FİYAT
1400	1 x 7 x 0,5 mm	100	7.80 USD
1401	7,5 x 15 x 0,5 mm	100	7.80 USD
1402	15,5 x 25 x 0,5 mm	100	7.80 USD

Plastik şeffaf poşettedir.

Çırt Zımpara Altı



Havalı Çırt Zımpara Altı 150 mm Delikli

ÖLÇÜ	KALINLIK			FİYAT
115 mm	10 mm	50	200	1.40 USD
180 mm	10 mm	25	100	2.90 USD



5.00 USD

100 adet

Lazerli Mesafe Ölçme MK 30



FONKSİYONLAR VE TEKNİK ÖZELLİKLERİ

- Ölçme mesafesi 0,15 - 30 metre
- Mesafeleri feet, inch, metre olarak ölçme özelliği
- Alan ve hacim hesaplama
- Lazer Diod 653 nm, sınıf II
- IP 54 standardında
- Uzaktan yükseklik ve uzunluk ölçmek için sabitleme, 1/4" vidalama
- LCD aydınlatmalı ekran
- 3 adet AAA Alkalin pil ile 5000 ölçüm yapabilme kapasitesi
- Toplama, çıkartma ve sürekli ölçüm metotları
- Hızlı yanıt süresi ve son 20 ölçümü hafızada tutabilme özelliği
- Otomatik güç kapatma
- Ölçümleri cihazın ön veya arka ucundan başlatabilme
- Pisagor fonksiyonu
- 140 gr ağırlığında
- 115 x 52 x 32 mm ebatlarında
- Orjinal kılıfı ve Türkçe-İngilizce kullanım kılavuzu



20

60.00 USD



Lazerli Mesafe Ölçme MK 60



FONKSİYONLAR VE TEKNİK ÖZELLİKLERİ

- Ölçme mesafesi 0,15 - 60 metre
- Mesafeleri feet, inch, metre olarak ölçme özelliği
- Alan ve hacim hesaplama
- Lazer Diod 653 nm, sınıf II
- IP 54 standardında
- Uzaktan yükseklik ve uzunluk ölçmek için sabitleme, 1/4" vidalama
- LCD aydınlatmalı ekran
- 3 adet AAA Alkalin pil ile 5000 ölçüm yapabilme kapasitesi
- Toplama, çıkartma ve sürekli ölçüm metotları
- Hızlı yanıt süresi ve son 20 ölçümü hafızada tutabilme özelliği
- Otomatik güç kapatma
- Ölçümleri cihazın ön veya arka ucundan başlatabilme
- Pisagor fonksiyonu
- 140 gr ağırlığında
- 115 x 52 x 32 mm ebatlarında
- Orjinal kılıfı ve Türkçe-İngilizce kullanım kılavuzu



20

75.00 USD



Otomatik Kendiliğinden Ayarlı Lazerli Su Terazisi SA 04

Lazerli Su Terazisi
Tripodlu 110 cm
Yatay, dikey ve çapraz lazer ışınları
yansıtır
Lazer dalga boyu 650 nm
2 adet alkalin pil AAA ile çalışır
Plastik Çantasında



55.00 USD

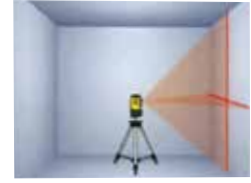
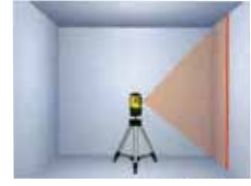

Lazerli Çırpı İpi SL 03

Lazerli Çırpı İpi
Lazer dalga boyu 650 nm
2 alkalin pil AAA ile çalışır



10.00 USD



Ultrasonik Mesafe Ölçme UM 01

Ultrasonik Mesafe Ölçme
LCD ekran
15 metre çalışma kapasitesi
9 Volt pil ile çalışır
Ses İkazlı
Uzunluk (m), alan (m²) ve hacim (m³) ölçümleri yapar



20.00 USD

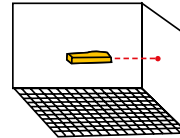

Mesafe ölçme

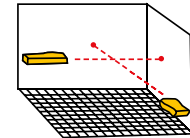

Alan ölçme

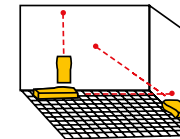

Hacim ölçme

Ultrasonik Mesafe Ölçme UM 02

Dijital Tarama

Ultrasonik Mesafe Ölçme
LCD ekran
15 metre çalışma kapasitesi
9 Volt pil ile çalışır
Ses İkazlı
Uzunluk (m), alan (m²) ve hacim (m³) ölçümleri yapar
Metal, ahşap, AC kablo bulma işlemi yapar



25.00 USD

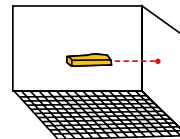

Mesafe ölçme

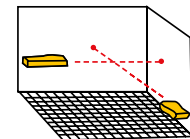

Alan ölçme

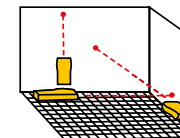

Hacim ölçme

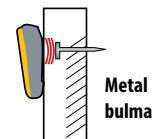

Metal bulma

Mekanik Kumpaslar 0.05 Hassasiyet



BOYUTLAR		FİYAT
100 mm	50	8.55 USD
150 mm	50	8.55 USD
200 mm	50	14.50 USD
300 mm	50	25.00 USD

Plastik kutulu

Monoblok Süper Kumpas



KOD	EBAT	FİYAT
1020	150 x 0,05 mm	19.90 USD
1021	200 x 0,05 mm	28.35 USD
1022	300 x 0,05 mm	52.00 USD

Plastik kutulu

Mekanik Kumpas Tek Çene



KOD	EBAT	FİYAT
1008	500 x 0,05 mm (Çene Boyu 100 mm)	47.00 USD
1009	600 x 0,05 mm (Çene Boyu 100 mm)	50.00 USD
1010	1000 x 0,05 mm (Çene Boyu 125 mm)	150.00 USD
1011	1500 x 0,05 mm (Çene Boyu 150 mm)	320.00 USD

Tahta kutulu

Uzun Çift Çeneli Kumpas



KOD	EBAT	FİYAT
1040	300 x 0,05 mm (Çene Boyu 90 mm)	58.50 USD
1041	500 x 0,05 mm (Çene Boyu 150 mm)	92.00 USD
1042	600 x 0,05 mm (Çene Boyu 150 mm)	98.00 USD
1043	1000 x 0,05 mm (Çene Boyu 150 mm)	238.00 USD

Tahta kutulu

Dijital Kumpas Büyük Ekranlı 0.01 Hassasiyet



YENİ

BOYUTLAR		FİYAT
100 x 0.01mm	50	19.00 USD
150 x 0.01mm	50	19.50 USD
200 x 0.01mm	50	30.00 USD
300 x 0.01mm	50	48.00 USD
500 x 0.01mm	50	135.00 USD

Plastik kutulu

Dijital Kumpas Metal Ekranlı 0.01 Hassasiyet



YENİ

KOD	BOYUTLAR		FİYAT
1060	150 x 0,01 mm	50	22.50 USD
1061	200 x 0.01 mm	50	33.50 USD
1062	300 x 0.01 mm	50	50.50 USD

Plastik kutulu

Mikrometre 0.01 Hassasiyet



YENİ

BOYUTLAR		FİYAT
0 - 25 mm	50	11.00 USD
25 - 50 mm	50	13.45 USD
50 - 75 mm	50	15.85 USD
75 - 100 mm	50	18.50 USD
100 - 125 mm	50	21.30 USD
125 - 150 mm	50	23.70 USD

Plastik kutulu

Dijital Dış Çap Mikrometresi



KOD	EBAT	FİYAT
1190	0 - 25 x 0,001 mm	70.50 USD
1191	25 - 50 x 0,001 mm	82.50 USD
1192	50 - 75 x 0,001 mm	97.00 USD
1193	75 - 100 x 0,001 mm	110.00 USD

Tahta kutulu

Numaratörlü Mikrometre



KOD	EBAT	FİYAT
1185	0 - 25 x 0,01 mm	34.40 USD
1186	25 - 50 x 0,01 mm	37.40 USD

Tahta kutulu

Komparatör Saati



KOD	EBAT	FİYAT
1300	0,10 x 0,01 mm (Kulaklı)	11.45 USD
1301	0,10 x 0,01 mm (Kulaksız)	11.45 USD

Uzun çubuklu

KOD	EBAT	FİYAT
1305	0 - 20 x 0,01 x 20 mm	23.80 USD
1306	0 - 30 x 0,01 x 30 mm	25.70 USD
1307	0 - 50 x 0,01 x 50 mm	64.50 USD

Köpüklü, dayanıklı, karton kutulu

Salgı Komparatör Saati



KOD	EBAT	FİYAT
1310	0,08 x 0,01 mm	30.00 USD
1311	0,08 x 0,01 mm 30 mm (Uzun Çubuklu)	36.50 USD

Plastik kutulu

Dijital Komparatör Saati



KOD	EBAT	FİYAT
1320	0 - 12,7 x 0,01 mm	29.00 USD
1321	0 - 12,7 x 0,001 mm (Mikronlu)	74.00 USD

Köpüklü, dayanıklı, karton kutulu

Cep Tipi Kalınlık Komparatörü



KOD	EBAT	FİYAT
1325	0 - 10 x 0,1 x 15 mm	10.50 USD
1326	0 - 20 x 0,1 x 20 mm	12.85 USD

Plastik kutulu

Boru Kalınlık Komparatörü



KOD	EBAT	FİYAT
1330	0 - 10 x 0,01 x 30 mm	33.00 USD

Plastik kutulu

Manyetik Ayak



KOD	EBAT	FİYAT
1380	Manyetik Komparatör Ayağı 60 Kgs.	12.00 USD

Köpüklü, dayanıklı, karton kutulu

Alüminyum Gönye



BOYUTLAR		FİYAT
200 mm	48	4.50 USD
250 mm	48	5.20 USD
300 mm	48	5.60 USD
350 mm	48	6.35 USD
400 mm	48	7.15 USD
500 mm	48	8.65 USD
600 mm	48	10.30 USD

6 lık kutular halinde.

Açılı Gönye



KOD	EBAT	FİYAT
1430	80 x 120 mm	12.20 USD
1431	120 x 150 mm	14.40 USD
1432	150 x 200 mm	15.10 USD

Deri kılıflı

Marangoz Gönyesi



BOYUTLAR		FİYAT
200 mm	120	1.60 USD
250 mm	120	1.70 USD
300 mm	120	1.80 USD
350 mm	120	2.00 USD
400 mm	120	2.15 USD
500 mm	60	2.35 USD
600 mm	60	2.50 USD

12 lık kutular halinde.

Kıl Gönyesi DIN 875/1



KOD	BOYUTLAR		FİYAT
1460	70x100 mm	100	11.00 USD
1461	100x150 mm	100	16.00 USD
1462	130x200 mm	100	22.00 USD

Tahta kutulu

Şapkalı Gönye DIN 875/1



YENİ

KOD	BOYUTLAR		FİYAT
1480	70x100 mm	100	9.80 USD
1481	100x150 mm	100	14.00 USD
1482	130x200 mm	100	18.50 USD
1483	160x250 mm	100	27.50 USD
1484	200x300 mm	100	36.50 USD
1485	250x400 mm	100	63.00 USD
1486	330x500 mm	100	110.00 USD

Karton kutulu

VOLA Taşçı Gönyesi 273 Modeli



YENİ

MODEL	BOYUT	FİYAT
273 modeli	50 x 25 cm	8.65 EURO
273 modeli	60 x 30 cm	10.30 EURO
273 modeli	80 x 40 cm	14.75 EURO
273 modeli	100 x 50 cm	17.40 EURO

Çanak Tel Fırça Saçaklı



ÖLÇÜ	VİDA ÇAPI		FIYAT
65 mm	M 14	100	1.65 USD
75 mm	M 14	80	2.00 USD
100 mm	M 14	36	3.30 USD
125 mm	M 14	24	5.30 USD

Çanak Tel Fırça Burgulu, Çelik Kuşaklı



ÖLÇÜ	VİDA ÇAPI		FIYAT
65 mm	M 14	100	2.85 USD
80 mm	M 14	36	4.50 USD
100 mm	M 14	36	6.15 USD
125 mm	M 14	24	7.80 USD

Dairesel Tel Fırça Çelik Telli

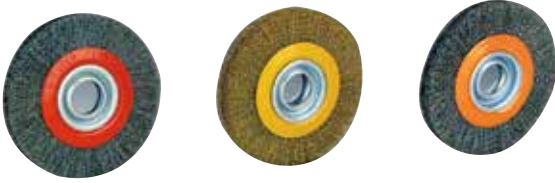

ÖLÇÜ		FIYAT
125 mm X 25	42	3.80 USD
150 mm X 25	32	4.60 USD
175 mm X 25	20	6.00 USD
200 mm X 25	20	7.15 USD

Plastik Saplı El Tipi Tel Fırça



MODEL		FIYAT
Sarı telli	180	1.00 USD
Gri telli	180	1.00 USD

Tel Fırça Ahşap



MODEL		FIYAT
No: 4	240	0.60 USD
No: 5	240	0.70 USD
No: 6	240	0.80 USD

Pimli Daire Fırça



YENİ

ÖLÇÜ	VİDA ÇAPI		FİYAT
50 mm	6 mm	270	0.70 USD
63 mm	6 mm	180	0.85 USD
75 mm	6 mm	180	1.10 USD
100 mm	6 mm	96	1.40 USD

Blister ambalajlı

Pimli Çanak Fırça



YENİ

ÖLÇÜ	VİDA ÇAPI		FİYAT
50 mm	6 mm	216	1.00 USD
63 mm	6 mm	120	1.10 USD
75 mm	6 mm	96	1.20 USD

Blister ambalajlı

Pimli Kalem Fırça



YENİ

ÖLÇÜ	VİDA ÇAPI		FİYAT
12 mm	6 mm	216	0.70 USD
17 mm	6 mm	216	0.80 USD
25 mm	6 mm	144	0.95 USD
30 mm	6 mm	120	1.20 USD

Blister ambalajlı

Pimli Fırça Seti



YENİ

5 parça sarı telli,
pimli fırça seti.**5.25 USD** 60

Makaralı Kablolar 3 x 1,5 mm



ÖLÇÜ		FİYAT
20 Metre	4	19.25 USD
35 Metre	4	26.60 USD
50 Metre	4	33.65 USD

Makaralı Kablolar 3 x 2,5 mm



ÖLÇÜ		FİYAT
20 Metre	4	23.50 USD
30 Metre	4	30.50 USD
40 Metre	4	37.50 USD
50 Metre	4	43.75 USD

Boş Makara (Kablosuz)

8.00 USD



YENİ



Epoksi Tabancası Alüminyum
345 ml

YENİ



6.25 USD



25

Epoksi Tabancası Alüminyum
410 ml

YENİ



11.00 USD



25

Silikon Tabancası Alüminyum
310 ml

YENİ



5.75 USD



25

Silikon Tabancası Plastik
310 ml

YENİ



2.00 USD



60

Sosis Tabancası 15" Alüminyum
600 ml

YENİ



11.00 USD



25

Elektrikli Silikon Mum Tabancaları



MODEL	GÜCÜ	ÖLÇÜ	DERECE		FİYAT
HL-20 W Anahtarlı	20 W	7.3 mm	193 °C	96	5.50 USD
FL-168 A Anahtarlı	60 W	11.3 mm	193 °C	48	8.80 USD
FL-188 AA (Şarjlı)	80 W	11.3 mm	193 °C	24	10.00 USD



Silikon Mum Çubuklar



ÖLÇÜ		FİYAT / kg
7,2 mm	25 kg	10.00 USD
11,3 mm	25 kg	10.50 USD
11,3 mm siyah	25 kg	11.00 USD

Elektrikli Kalem Havyalar ve Lehim Pompaları



MODEL	GÜCÜ		FİYAT
EKH-30	30 W	50	5.00 USD
EKH-40	40 W	50	5.50 USD
EKH-60	60 W	50	7.00 USD
EKH-80	80 W	50	8.00 USD
Lehim Pompası Metal	-	100	3.00 USD

Elektrikli Kalem Havyalar Balta Tipi



YENİ

MODEL	GÜCÜ		FİYAT
EKH-100	100 W	50	13.00 USD
EKH-150	150 W	50	14.00 USD
EKH-200	200 W	50	17.50 USD

Tabanca Havya

220 - 240 V 50 Hz
Işıklı
175 Watt



19.00 USD



10

Sıcak Hava Tabancası

220 - 240 V 50 Hz
2000 Watt
2 Kademeli
1- 250 °C, 250 Lt/dak
2- 550 °C, 550 Lt/dak
Derece Ayarlı



25.00 USD



10

Çakmaklı Tavlama OL-600



15.00 USD



60

Çakmaklı Tavlama ET-260



13.50 USD



100

Hidrolik Şişe Krikolar

CE



KALDIRMA KAPASİTESİ	KALDIRMA YÜKSEKLİĞİ	MİNİMUM YÜKSEKLİK	AYARLANABİLİR YÜKSEKLİK	NET AĞIRLIK		FİYAT
2 Ton	90 mm	158 mm	60 mm	2,30 kg	10	18.20 USD
3 Ton	110 mm	180 mm	60 mm	3,30 kg	8	23.80 USD
5 Ton	125 mm	197 mm	60 mm	4,40 kg	6	30.80 USD
10 Ton	125 mm	205 mm	60 mm	6,00 kg	4	40.60 USD
15 Ton	125 mm	205 mm	60 mm	8,00 kg	4	58.00 USD
20 Ton	145 mm	244 mm	60 mm	11,00 kg	2	70.00 USD
30 Ton	180 mm	285 mm		14,60 kg	2	115.00 USD

Araba Sehpası

CE



Çift emniyet sistemli
12 kademeli ayarlanabilme özelliği
Çelik sap ve kilitleme özelliği
Geniş oturum yüzeyi

KALDIRMA KAPASİTESİ	MAKSİMUM YÜKSEKLİK	MİNİMUM YÜKSEKLİK	NET AĞIRLIK		ÇİFT FİYATI
2 Ton	425 mm	268 mm	5,00 kg	2	35.00 USD
3 Ton	450 mm	305 mm	6,50 kg	2	43.00 USD
6 Ton	625 mm	395 mm	14,50 kg	2	72.00 USD

Fiyatlar bir çift fiyatlandır.

2 Ton Garaj Krikosu



YENİ

CE

Çantalı

Plastik
çanta içinde

51.00 USD



KALDIRMA KAPASİTESİ	MAKSİMUM YÜKSEKLİK	MİNİMUM YÜKSEKLİK	KALDIRMA YÜKSEKLİĞİ	NET AĞIRLIK
2 Ton	320 mm	120 mm	200 mm	8,40 kg

Kutulu

Renkli
karton kutu içinde

48.00 USD



KALDIRMA KAPASİTESİ	MAKSİMUM YÜKSEKLİK	MİNİMUM YÜKSEKLİK	KALDIRMA YÜKSEKLİĞİ	NET AĞIRLIK
2 Ton	335 mm	135 mm	200 mm	8,50 kg

3 Ton Garaj Krikosu



YENİ

CE

Renkli
karton kutu içinde



200.00 USD



KALDIRMA KAPASİTESİ	MAKSİMUM YÜKSEKLİK	MİNİMUM YÜKSEKLİK	KALDIRMA YÜKSEKLİĞİ	NET AĞIRLIK
3 Ton	410 mm	135 mm	360 mm	16,00 kg



**Mıknatıslı Bits S2 Kalite
Yıldız Tornavida Uçları 1/4"**
PH 25 mm



MODEL	BOYUT			FİYAT
PH1	25 mm	50	2500	0.13 USD
PH2	25 mm	50	2500	0.13 USD
PH3	25 mm	50	2500	0.13 USD



**Mıknatıslı Bits S2 Kalite
Yıldız Tornavida Uçları 1/4"**
PH 50 mm



MODEL	BOYUT			FİYAT
PH00	50 mm	30	1500	0.40 USD
PH0	50 mm	30	1500	0.25 USD
PH1	50 mm	30	1500	0.25 USD
PH2	50 mm	30	1500	0.25 USD
PH3	50 mm	30	1500	0.25 USD

**Mıknatıslı Bits S2 Kalite
Yıldız Tornavida Uçları 1/4"**
PH 75 mm



MODEL	BOYUT			FİYAT
PH1	75 mm	20	1000	0.40 USD
PH2	75 mm	20	1000	0.40 USD
PH3	75 mm	20	1000	0.40 USD

**Mıknatıslı Bits S2 Kalite
Yıldız Tornavida Uçları 1/4"**
PH 100 mm



MODEL	BOYUT			FİYAT
PH2	100 mm	10	1000	0.75 USD

PH 150 mm

MODEL	BOYUT			FİYAT
PH2	150 mm	10	500	1.25 USD

PH 200 mm

MODEL	BOYUT			FİYAT
PH2	200 mm	10	500	1.90 USD

YENİ

**Mıknatıslı Bits S2 Kalite
Pozi Tornavida Uçları 1/4"
PZ 25 mm**



MODEL	BOYUT			FİYAT
PZ1	25 mm	100	2500	0.13 USD
PZ2	25 mm	100	2500	0.13 USD
PZ3	25 mm	100	2500	0.13 USD

**Mıknatıslı Bits S2 Kalite
Pozi Tornavida Uçları 1/4"
PZ 50 mm**



MODEL	BOYUT			FİYAT
PZ1	50 mm	30	1500	0.25 USD
PZ2	50 mm	30	1500	0.25 USD
PZ3	50 mm	30	1500	0.25 USD

**Mıknatıslı Bits S2 Kalite
Pozi Tornavida Uçları 1/4"
PZ 75 mm**



MODEL	BOYUT			FİYAT
PZ1	75 mm	20	1000	0.40 USD
PZ2	75 mm	20	1000	0.40 USD
PZ3	75 mm	20	1000	0.40 USD

**Mıknatıslı Bits S2 Kalite
Pozi Tornavida Uçları 1/4"
PZ 100 mm**



PZ 100 mm

MODEL	BOYUT			FİYAT
PZ2	100 mm	10	1000	0.75 USD

PZ 150 mm

MODEL	BOYUT			FİYAT
PZ2	150 mm	10	500	1.25 USD

**Mıknatıslı Bits S2 Kalite
Düz Tornavida Uçları 1/4"
SL 25 mm**



MODEL	BOYUT			FİYAT
SL 5.0 X 0.8	25 mm	100	1200	0.13 USD
SL 5.5 X 0.8	25 mm	100	1200	0.13 USD
SL 6.0 X 1.0	25 mm	100	1200	0.13 USD

**Mıknatıslı Bits S2 Kalite
Düz Tornavida Uçları 1/4"
SL 50 mm**



MODEL	BOYUT			FİYAT
SL 5.0 X 0.8	50 mm	25	1000	0.25 USD
SL 5.5 X 0.8	50 mm	25	1000	0.25 USD
SL 6.0 X 1.0	50 mm	25	1000	0.25 USD
SL 6.5 X 1.2	50 mm	25	1000	0.25 USD

**Mıknatıslı Bits S2 Kalite
Torx Tornavida Uçları 1/4"
50 mm**



MODEL	BOYUT			FİYAT
T 20	50 mm	25	1000	0.25 USD
T 27	50 mm	25	1000	0.25 USD
T 30	50 mm	30	1500	0.25 USD
T 40	50 mm	30	1500	0.25 USD
T 45	50 mm	25	1000	0.25 USD

**Mıknatıslı Bits S2 Kalite
Torx Tornavida Uçları 1/4"
75 mm**



MODEL	BOYUT			FİYAT
T 20	75 mm		1000	0.40 USD
T 30	75 mm	20	1000	0.40 USD
T 20	100 mm	10	1000	0.75 USD
T 30	100 mm	10	1000	0.75 USD
T 20	150 mm	10	650	1.25 USD
T 30	150 mm	10	650	1.25 USD

**Mıknatıslı Bits S2 Kalite
Allen Tornavida Uçları 1/4"
50 mm**



MODEL	BOYUT			FİYAT
HEX 4	50 mm	25	1000	0.25 USD
HEX 5	50 mm	25	1000	0.25 USD

Mıknatıslı Bits S2 Kalite Çift Uçlu Düz * Yıldız Torna Vida Uçları 1/4" 60 mm



MODEL	BOYUT			FİYAT
5.0 X 0.8 + PH2	60 mm	18	900	0.45 USD

Mıknatıslı Bits Uç Adaptörü

YENİ



MODEL	BOYUT			FİYAT
Adaptör	60 mm	10	500	0.45 USD
Adaptör Yekpare	60 mm	10	100	1.00 USD
Adaptör	100 mm	5	50	0.75 USD
Adaptör	150 mm	5	50	0.95 USD
Adaptör Bilyeli	60 mm	5	50	3.00 USD
Adaptör Paslanmaz	60 mm	10	50	1.30 USD
Adaptör Paslanmaz	100 mm	10	50	1.50 USD
Adaptör Paslanmaz	150 mm	10	50	1.85 USD

Mıknatıslı Somun Adaptörleri



MODEL			FİYAT
45 mm X 8	10	500	0.45 USD
45 mm X 10	8	400	0.50 USD
65 mm X 6	5	500	0.45 USD
65 mm X 7	5	500	0.50 USD
65 mm X 8	10	500	0.55 USD
65 mm X 10	8	400	0.75 USD
65 mm X 11	5	250	0.85 USD
65 mm X 12	5	250	0.95 USD
65 mm X 13	5	250	1.05 USD
65 mm X 14	5	250	1.25 USD
65 mm X 15	5	250	1.95 USD
65 mm X 16	5	250	2.15 USD
65 mm X 17	5	250	2.40 USD
65 mm X 19	5	250	2.65 USD

Manyetik Somun Lokması Ekstra Uzun

YENİ



MODEL	BOYUT			FİYAT
Somun Lokması	8x150 mm	5	500	2.30 USD
Somun Lokması	10x150 mm	5	400	2.50 USD
Somun Lokması	13x150 mm	5	400	3.00 USD

SDS Lokma Adaptörü



YENİ

ÖZELLİK			FİYAT
1/4 x 65 SDS	10	100	1.50 USD
1/2 x 73 SDS	4	40	1.80 USD

HEX Lokma Adaptörü



YENİ

ÖZELLİK			FİYAT
1/4 x 65 HEX	10	100	0.85 USD
1/2 x 73 HEX	4	40	1.30 USD

Bits Uzatma Adaptörü
Bükülebilir

BOYUT		FİYAT
1/4" x 300 mm x 1/4"	200	4.00 USD

Mıknatıslı Bits Uç Seti
100 Parça 1/4"

MODEL		FİYAT
100 Parça	12	18.00 USD

Mıknatıslı
SDS Bits Ara Adaptörü

	FİYAT
50	1.05 USD

Mıknatıslı Şapkalı Yıldız
Bits Uç PH2 x 25 mm

50 lik kutular halinde

	FİYAT
1400	0.30 USD

1453 İş Güvenlik Ayakkabısı

Süet

Çelik Burun

No: 36 - 46
 Çelik burunlu
 200 J darbeye dayanıklı
 Antistatik
 Şok emici topuk
 PU + PU taban
 Çelik ara taban opsiyonel



YENİ

15.00 USD

 20 Çift

571 İş Güvenlik Ayakkabısı

Deri

Çelik Burun

No: 36 - 46
 Çelik burunlu
 200 J darbeye dayanıklı
 Antistatik
 Şok emici topuk
 PU + PU taban
 Çelik ara taban opsiyonel



YENİ

14.00 USD

 20 Çift

571 İş Güvenlik Botu

Deri

Çelik Burun

No: 36 - 46
 Çelik burunlu
 200 J darbeye dayanıklı
 Antistatik
 Şok emici topuk
 PU + PU taban
 Çelik ara taban opsiyonel



YENİ

15.00 USD

 20 Çift

Çelik ara taban farkı her ürün için 5 TL dir.

Kolormatik Kaynakçı Baş Maskesi



30.00 USD



6

DIN EN 175

CE

FONKSİYONLAR VE TEKNİK ÖZELLİKLERİ

- İzleme alanı 92 x 42 mm
- Filtre boyutları 110 x 90 x 9 mm
- UV / IR koruma DIN 16
- Açık konum DIN 4
- Değiştirilebilen kararım konumu DIN 9 - DIN 13
- Güç açma / kapama otomatik
- Güç kaynağı güneş enerjisi, pil değişimine ihtiyaç yoktur
- Hassasiyet alçak - yüksek, çevreye göre ayarlanabilir
- Toplam ağırlık 490 gr
- Renkli orjinal kutusunda



Kaynakçı Pensesi



MODEL		FİYAT
400 Amper	50	4.40 USD
600 Amper	50	5.50 USD

Şase Pense İzoleli



YENİ

ÜRÜN		FİYAT
300 A	100	6.00 USD
500 A	50	7.80 USD

Şase Pense



YENİ

ÜRÜN		FİYAT
300 A	100	4.25 USD
500 A	50	6.35 USD

Kaynak Tutucuları



YENİ

ÜRÜN		FİYAT
50 LBS	100	6.00 USD
75 LBS	100	7.50 USD

LEDEN ARC 200 3 KARTLI Inverter Kaynak Makinası 220 V. 200 Amper

MMA (Örtülü Elektrot Kaynağı)
İnvertör özelliği sayesinde düşük enerji kullanımı
Rutil ve bazik elektrot yakabilme (2,5 mm - 3,25 mm - 4.00 mm)
Aşırı ısınmaya karşı termik koruma
Kolay akım ayarı için amper ayar ekranı
4 kg ağırlığı ile kolay taşınabilme
Jeneratör ile uyumlu
2 yıl garantili

Kullanım alanları

Demir doğramacılar, bakım onarım atölyeleri, tesisatçılar ve dış ortamlarda çalışanlar için idealdir.



YENİ



350.00 USD



1

Şebeke gerilimi: 220 V - 50/60 Hz.
Çıkış akımı: 20 - 200 Amper
Boşta çalışma gerilimi: 65 V.
Devrede kalma oranı: %40
Kaynak verimi: %85
Ağırlık: 4.7 kg
Ölçü: 310 x 125 x 250 mm
Elektrot çapı: 1,6 - 4,0 mm
KVA: 9.1

HYLONG ARC 202 Inverter Kaynak Makinası 220 V. 200 Amper



YENİ

250.00 USD



1

Giriş gücü gerilim: 220 V. 50/60 Hz.
Nominal giriş kapasitesi (KVA) : 7,8
Çıkış akım ayar aralığı (A) : 20 - 160
Nominal çıkış gerilimi (V) : 20,8 - 26,4
Verimlilik (%) : 85
Yük voltaj kapasitesi (V) : 65
Boyut (mm) : 415 x 235 x 310
Ağırlık (kg) : 2,7
Soğutma şekli : Hava
Çubuk çapı (mm) : 1,6 - 2,5 - 3,25

PLUS-STICK 200 TIG Kaynak Makinası 220 V. 200 Amper



Lift TIG özelliği sayesinde yüksek frekansta ihtiyaç duymadan TIG kaynağı yapmayı sağlar.

YENİ

375.00 USD



1

Güç kaynağı voltajı: 1 - 230 V
Etkili akım (A) : 36/25
Giriş gücü (KW) : 6,8 - 4,5
Giriş akımı (A) : 47 / 32
Verimlilik (%) : 85
Açık devre voltajı (V) : 61
Boyut (mm) : 370 x 146 x 278
Ağırlık (kg) : 6,2
Soğutma şekli : AF
Çubuk çapı (mm) : 1,6 - 5,0

GTAW 200 P**Koruma**

Yüksek koruma için sıcaklık voltajı ve akım sensörleri ile donatılmıştır.

Pulse

Pulse özelliği sayesinde deformasyon olmadan ultra ince yüzeylerde mükemmel performans

Spot Süresi

Spot Süresi/ Darbe Süresi fonksiyonu seçilebilir.

2 Yıl Garantilidir.



MODEL	GÜÇ KAYNAĞI VOLTAJ (V)	ETKİLİ AKIM	GİRİŞ GÜCÜ (KW)	GİRİŞ AKIMI (A)	DEVREDE KALMA ORANI (40 °C 10 MİN)	ACIK DEVRE VOLTAJ (V)	KAYNAK AKIM ARALIĞI (A)	NET AĞIRLIK (Kg)	ÖLÇÜLER	FİYAT
GTAW 200 P	1 - 230	TIG 20 MMA 26	TIG 4.9 MMA 6.2	TIG 34 MMA 44	35% 200 A 60% 125 A 100% 100 A	85	5 - 200	7,0	410 X 146 X 278	1,000.00 USD

GTAW 270-1 CEL**Yukarı/ Aşağı Eğim**

Yukarı/ Aşağı eğim süresi seçilebilir.

Akış Öncesi/ Sonrası

Akış öncesi/ akış sonrası seçilebilir.

2T /4T Modu

2T / 4T modu ile kaynak imkanı.

Ağırlık

Düşük ağırlık ve boyut, taşınması kolay.

Koruma

Yüksek koruma için sıcaklık voltajı ve akım sensörleri ile donatılmıştır.

2 yıl garantilidir.



MODEL	GÜÇ KAYNAĞI VOLTAJ (V)	ETKİLİ AKIM	GİRİŞ GÜCÜ (KW)	GİRİŞ AKIMI (A)	DEVREDE KALMA ORANI (40 °C 10 MİN)	ACIK DEVRE VOLTAJ (V)	KAYNAK AKIM ARALIĞI (A)	NET AĞIRLIK (Kg)	ÖLÇÜLER	FİYAT
GTAW 270-1	1 - 230	TIG 25 MMA 35	TIG 6.1 MMA 8.8	TIG 40 MMA 55	40% 250 A 60% 200 A 100% 180 A	70	5 - 250	10	492 X 189 X 350	1,000.00 USD

GTAW 250-1 PULSE CEL

Yukarı/ Aşağı Eğim

Yukarı/ Aşağı eğim süresi seçilebilir.

Akış Öncesi/ Sonrası

Akış öncesi/ akış sonrası seçilebilir.

2T /4T Modu

2T / 4T modu ile kaynak imkanı.

Ağırlık

Düşük ağırlık ve boyut, taşınması kolay.

Koruma

Yüksek koruma için sıcaklık voltajı ve akım sensörleri ile donatılmıştır.

2 yıl garantilidir.



MODEL	GÜÇ KAYNAĞI VOLTAJ (V)	ETKİLİ AKIM	GİRİŞ GÜCÜ (KW)	GİRİŞ AKIMI (A)	DEVREDE KALMA ORANI (40 °C 10 MİN)	ACIK DEVRE VOLTAJ (V)	KAYNAK AKIM ARALIĞI (A)	NET AĞIRLIK (Kg)	ÖLÇÜLER	FİYAT
GTAW 250-1	1 - 230	TIG 25 MMA 35	TIG 6.1 MMA 8.8	TIG 40 MMA 55	40% 250 A 60% 200 A 100% 180 A	70	5 - 250	10	492 X 189 X 350	1,100.00 USD

GTAW 200P AC/DC

AC Denge Kontrolü

AC denge kontrolü oksit izler ve alüminyum kaynağı arasında daha iyi temizlemeye yardımcı olur.

Koruma

Yüksek koruma için sıcaklık voltajı ve akım sensörleri ile donatılmıştır.

Dalga Şekilleri

Kare dalga, sinüs dalga, seçilebilir.

Spot Süresi

Spot Süresi/ Darbe Süresi fonksiyonu seçilebilir.

2 yıl garantilidir.



MODEL	GÜÇ KAYNAĞI VOLTAJ (V)	ETKİLİ AKIM	GİRİŞ GÜCÜ (KW)	GİRİŞ AKIMI (A)	DEVREDE KALMA ORANI (40 °C 10 MİN)	ACIK DEVRE VOLTAJ (V)	KAYNAK AKIM ARALIĞI (A)	NET AĞIRLIK (Kg)	ÖLÇÜLER	FİYAT
GTAW 200P AC/DC	1 - 230	29 DC/MMA 26 AC/MMA 21 DC/TIG 20 AC/TIG	TIG 4.3 MMA 6.2	48 DC/MMA 44 AC/MMA 35 DC/TIG 34 AC/TIG	35% 200 A 60% 155 A 100% 120 A	72	5 - 200	10	465 X 146 X 278	2,200.00 USD

PRO - GTAW 3 / 320P / 400P**Tig Modu**

Lift TIG özelliği sayesinde yüksek frekansta ihtiyaç duymadan TIG kaynağı yapmayı sağlar.

Ekstra Özellik

Hot Start/ Arc Force yapışma önleyici ayarı

Ağırlık

Taşınabilir kompakt tasarım

Koruma

Yüksek koruma için sıcaklık voltajı ve akım sensörleri ile donatılmıştır.

2 yıl garantilidir.



MODEL	GÜÇ KAYNAĞI VOLTAJİ (V)	ETKİLİ AKIM	GİRİŞ GÜCÜ (KW)	GİRİŞ AKIMI (A)	DEVREDE KALMA ORANI (40 °C 10 MİN)	ACIK DEVRE VOLTAJİ (V)	KAYNAK AKIM ARALIĞI (A)	NET AĞIRLIK (Kg)	ÖLÇÜLER	FİYAT
PRO-GTAW 320P	3 - 400	TIG 9.5 MMA 11.5	TIG 19 MMA 23	TIG 15 MMA 18	60% 320 A 100% 250 A	70	5 - 320	20	530 X 240 X 445	3,250.00 USD
PRO-GTAW 400P	3 - 400	TIG 12 MMA 16	TIG 25.5 MMA 31.5	TIG 20 MMA 24	60% 400 A 100% 310 A	70	5 - 400	23.5	530 X 240 X 445	3,750.00 USD

PRO - GTAW 320P / 400P AC/DC**AC Denge Kontrolü**

AC denge kontrolü oksit izler ve alüminyum kaynağı arasında daha iyi temizlemeye yardımcı olur.

Koruma

Yüksek koruma için sıcaklık voltajı ve akım sensörleri ile donatılmıştır.

Dalga Şekilleri

Kare dalga, sinüs dalga, seçilebilir.

2 yıl garantilidir.



MODEL	GÜÇ KAYNAĞI VOLTAJİ (V)	ETKİLİ AKIM	GİRİŞ GÜCÜ (KW)	GİRİŞ AKIMI (A)	DEVREDE KALMA ORANI (40 °C 10 MİN)	ACIK DEVRE VOLTAJİ (V)	KAYNAK AKIM ARALIĞI (A)	NET AĞIRLIK (Kg)	ÖLÇÜLER	FİYAT
PRO-GTAW 320P AC/DC	3 - 380	TIG 14 MMA 18.5	TIG 9 MMA 13	TIG 18 MMA 24	60% 320 A 100% 250 A	67	10 - 320	25.5	550 X 240 X 445	4,500.00 USD
PRO-GTAW 400P AC/DC	3 - 380	TIG 19 MMA 25	TIG 13 MMA 17	TIG 25 MMA 32	60% 400 A 100% 310 A	67	10 - 400	27	550 X 240 X 445	5,750.00 USD

GMAW 250-1 / 315-3

Tel Besleyici

4 rulo tel besleyici mevcuttur.

ARC Kararlılığı

Düşük akımda bile arkın ek stabilitesi için dalga formu kontrolü.

Koruma

Yüksek koruma için sıcaklık voltajı ve akım sensörleri ile donatılmıştır.

15 kg'lık tel kapasitesi

Elektrot kaynağı yapılabilir.

2 yıl garantilidir.



MODEL	GÜÇ KAYNAĞI VOLTAJ (V)	ETKİLİ AKIM	GİRİŞ GÜCÜ (KW)	GİRİŞ AKIMI (A)	DEVREDE KALMA ORANI (40 °C 10 MİN)	ACIK DEVRE VOLTAJ (V)	KAYNAK AKIM ARALIĞI (A)	NET AĞIRLIK (Kg)	ÖLÇÜLER	FİYAT
GMAW 250-3	1 - 400	16	7.6	21	60% 250 A 100% 200 A	48	50 - 250	25	618 X 240 X 445	2,000.00 USD
GMAW 315	3	15	11	24	40% 315 A 60% 250 A 100% 200 A	53	50 - 315	25	618 X 240 X 445	2,500.00 USD

PC 40 Air

Pilot Ark Denetleyici

Pilot ark teknolojisi sayesinde kesme yetenekleri hızını artırır. Sarf malzeme sarfiyatını azaltır.

Kesme Kapasitesi

Karbon çelik, Paslanmaz çelik, Alüminyum, Bakır.

Koruma

Yüksek koruma için sıcaklık voltajı ve akım sensörleri ile donatılmıştır.

2 yıl garantilidir.



MODEL	GÜÇ KAYNAĞI VOLTAJ (V)	ETKİLİ AKIM	GİRİŞ GÜCÜ (KW)	GİRİŞ AKIMI (A)	DEVREDE KALMA ORANI (40 °C 10 MİN)	ACIK DEVRE VOLTAJ (V)	KESME AKIMI ARALIĞI (A)	NET AĞIRLIK (Kg)	ÖLÇÜLER	FİYAT
PC 40 Air	1 - 230	25	4.7	33	60% 40 A 100% 30 A	25	20 - 40	17,9	480 X 210 X 340	2,000.00 USD

PC 65

Pilot Ark Denetleyici

Pilot ark teknolojisi sayesinde kesme yetenekleri hızını artırır.
Sarf malzeme sarfiyatını azaltır.

Kesme Kapasitesi

Karbon çelik, Paslanmaz çelik, Alüminyum, Bakır.

Koruma

Yüksek koruma için sıcaklık voltajı ve akım sensörleri ile donatılmıştır.

2 yıl garantilidir.



MODEL	GÜÇ KAYNAĞI VOLTAJ (V)	ETKİLİ AKIM	GİRİŞ GÜCÜ (KW)	GİRİŞ AKIMI (A)	DEVREDE KALMA ORANI (40 °C 10 MİN)	ACIK DEVRE VOLTAJ (V)	KESME AKIMI ARALIĞI (A)	NET AĞIRLIK (Kg)	ÖLÇÜLER	FİYAT
PC 65	3 -400	17	7.8	18	90% 65 A 100% 61 A	450	20 - 65	24	640 X 240 X 445	2,750.00 USD

PC 120

Ekran

Tüm kesme parametrelerinin dijital kontrolü

Pilot Ark Denetleyici

Pilot ark teknolojisi sayesinde kesme yetenekleri hızını artırır.
Sarf malzeme sarfiyatını azaltır.

Kesme Kapasitesi

Karbon çelik, Paslanmaz çelik, Alüminyum, Bakır.

Koruma

Yüksek koruma için sıcaklık voltajı ve akım sensörleri ile donatılmıştır.

2 yıl garantilidir.



MODEL	GÜÇ KAYNAĞI VOLTAJ (V)	ETKİLİ AKIM	GİRİŞ GÜCÜ (KW)	GİRİŞ AKIMI (A)	DEVREDE KALMA ORANI (40 °C 10 MİN)	ACIK DEVRE VOLTAJ (V)	KESME AKIMI ARALIĞI (A)	NET AĞIRLIK (Kg)	ÖLÇÜLER	FİYAT
PC 120	3 -400	28	14.5	36	60% 120 A 100% 100 A	420	20 - 100	30,5	660 X 240 X 445	4,750.00 USD

LDR-KE Erkek Kablo Fişi



ÜRÜN	ÖLÇÜ	A (max)		FİYAT
LDR-10-25 KE	14 mm	200	100	1.70 USD
LDR-35-70 KE (ithal)	21 mm	250 - 400	100	3.00 USD
LDR-35-70 KE	21 mm	250 - 400	50	4.45 USD
LDR-70-95 KE	24 mm	400 - 600	25	7.70 USD
LDR-70-95 KE	24 mm	400 - 600	25	7.70 USD

LDR-KE Dişi Kablo Fişi



ÜRÜN	ÖLÇÜ	A (max)		FİYAT
LDR-10-25 KD	14 mm	200	100	1.70 USD
LDR-35-70 KD	21 mm	250 - 400	50	4.45 USD
LDR-70-95 KD	24 mm	400 - 600	25	7.70 USD

LDR-MD Dişi Makine Soketi



ÜRÜN	ÖLÇÜ	A (max)		FİYAT
LDR-10-25 KE	14 mm	200	100	1.70 USD
LDR-35-70 KE (ithal)	21 mm	250 - 400	100	3.00 USD
LDR-35-70 KE	21 mm	250 - 400	50	4.45 USD
LDR-70-95 KE	24 mm	400 - 600	25	7.70 USD
LDR-70-95 KE	24 mm	400 - 600	25	7.70 USD

MIG Kaynak Torçları

ÜRÜN		FİYAT
LDR 15 MIG TORÇ (3MT-180A)	5	90.00 USD
LDR 15 MIG TORÇ (4MT-180A)	5	96.00 USD
LDR 15 MIG TORÇ (5MT-180A)	5	102.00 USD
LDR 15 MİNİ TORÇ (3MT-180A)	5	98.00 USD
LDR 15 MİNİ TORÇ (4MT-180A)	5	106.00 USD
LDR 25 MIG TORÇ (3MT-250A)	5	98.00 USD
LDR 25 MIG TORÇ (4MT-250A)	5	106.00 USD
LDR 25 MIG TORÇ (5MT-250A)	5	114.00 USD
LDR 36 MIG TORÇ (3MT-360A)	5	99.00 USD
LDR 36 MIG TORÇ (4MT-360A)	5	111.00 USD
LDR 36 MIG TORÇ (5MT-360A)	5	121.00 USD
LDR 501 MIG TORÇ (3MT-500A)SU SOĞUTMALI	5	121.00 USD
LDR 501 MIG TORÇ (4MT-500A)SU SOĞUTMALI	5	135.00 USD
LDR 501 MIG TORÇ (5MT-500A)SU SOĞUTMALI	5	145.00 USD

MIG / MAG Kaynak Torç Boyunları

ÜRÜN		FİYAT
LDR 15 DEVE BOYNU	25	4.45 USD
LDR 25 DEVE BOYNU	25	10.35 USD
LDR 36 DEVE BOYNU	25	11.10 USD
LDR 501 DEVE BOYNU (SU SOĞUTMALI)	25	17.00 USD
LDR 501 OTOMASYON DEVE BOYNU (SU SOĞUTMALI)	25	28.40 USD
LDR 601 DEVEBOYNU (SU SOĞUTMALI)	25	28.85 USD
LDR 601 OTOMASYON DEVEBOYNU (SU SOĞUTMALI)	25	40.70 USD

MIG / MAG Kaynak Torç Nozulları

ÜRÜN		FİYAT
LDR 15 KONİK NOZUL (KAPLAMALI)	50	1.95 USD
LDR 24/240 KONİK NOZUL	50	2.25 USD
LDR 25 KONİK NOZUL (KAPLAMALI)	50	2.45 USD
LDR 25 KONİK NOZUL (BAKIR)	50	2.15 USD
LDR 36 KONİK NOZUL (BAKIR)	50	2.95 USD
LDR 36 KONİK NOZUL (KAPLAMALI)	50	3.25 USD
LDR 501 KONİK NOZUL	50	2.60 USD
LDR 501/26 KONİK NOZUL (KALIN)	50	3.70 USD

MIG /MAG Kaynak Torç Meme Tutucuları

ÜRÜN		FİYAT
LDR 15 MEME TUTUCU	50	0.73 USD
LDR 15 NOZUL YAYI	50	0.15 USD
LDR 25 MEME TUTUCU (M8)	50	0.67 USD
LDR 25 MEME TUTUCU (M6)	50	0.67 USD
LDR 25 NOZUL YAYI	50	0.15 USD
LDR 36 MEME TUTUCU (M6)	50	0.60 USD
LDR36 MEME TUTUCU(M8)	50	0.60 USD
LDR 501 MEME TUTUCU	50	0.67 USD

MIG / MAG Kaynak Torç Gaz Dağıtıcıları

ÜRÜN		FİYAT
LDR 24 DİFÜZÖR (TEFLON)	50	0.37 USD
LDR 36 DİFÜZÖR (TEFLON)	50	0.24 USD
LDR 501/601 DİFÜZÖR (TEFLON)	50	0.24 USD

MIG / MAG Kaynak Torç Kabzaları

ÜRÜN		FİYAT
LDR MIG KABZA - İTHAL	50	5.20 USD
LDR MIG KABZA (YERLİ)	50	3.70 USD

MIG / MAG Kaynak Torç Dip Adaptör ve Somunları

ÜRÜN		FİYAT
LDR 15/24/25/36 DİP ADAPTÖRÜ	10	7.18 USD
LDR 240/501/600 DİP ADAPTÖRÜ	10	10.51 USD
LDR DİP ADAPTÖR SOMUNU (SİYAH)	10	2.77 USD

MIG / MAG Kaynak Torç Kontak Memeleri

ÜRÜN		FİYAT
LDR M6. 0 6. 0,6 /C	100	0.58 USD
LDR M6. 0 6. 0,8 /C	100	0.58 USD
LDR M6. 0 6. 1,0 /C	100	0.58 USD
LDR M6. 0 6. 1,2 /C	100	0.58 USD
LDR M6. 0 8. 0,8 /C	100	0.58 USD
LDR M6. 0 8. 1,0 /C	100	0.58 USD
LDR M6. 0 8. 1,2 /C	100	0.58 USD
LDR M8. 0 8. 0,8 /C	100	0.73 USD
LDR M8. 0 8. 1,0 /C	100	0.73 USD
LDR M8. 0 8. 1,2 /C	100	0.73 USD
LDR M8. 1 0. 0,8 /C	100	0.73 USD
LDR M8. 1 0. 1,0 /C	100	0.73 USD
LDR M8. 1 0. 1,2 /C	100	0.73 USD
LDR M8. 1 0. 1,6 /C	100	0.73 USD
LDR M8 * 30 * 1,0 CU/CR/ZR ZİRKONYUMLU	100	1.63 USD
LDR M8 * 30 * 1,2 CU/CR/ZR ZİRKONYUMLU	100	1.63 USD

TIG Kaynak Torç Pensleri

ÜRÜN		FİYAT
LDR COLLET (17 /18/26) 2,0 MM (10N23M)	10	0.63 USD
LDR COLLET (17 /18/26) 2,4 MM (10N24)	10	0.63 USD
LDR COLLET (17/18/26) 3,2 MM (10N25)	10	0.63 USD
LDR COLLET (9/20/25) 2,0 MM (70066WT)	10	0.48 USD
LDR COLLET (9/20/25) 2,4MM (13N23)	10	0.48 USD
LDR COLLET (9/20/25) 3,2MM (13N24)	10	0.48 USD

TIG Kaynak Torçları Boyunları

ÜRÜN		FİYAT
LDR WP 9 TIG BOYUN	10	6.72 USD
LDR WP 9F TIG BOYUN (BÜKÜLEBİLİR)	10	7.68 USD
LDR WP 17 TIG BOYUN	10	9.18 USD
LDR WP 17F TIG BOYUN (BÜKÜLEBİLİR)	10	13.28 USD
LDR WP 17VF TIG BOYUN (VANALI-BÜKÜLEBİLİR)	10	16.40 USD
LDR WP 18 TIG BOYUN (SU SOĞUTMALI)	10	11.53 USD
LDR WP 18F TIG BOYUN (SU SOĞUTMALI BÜKÜLEBİLİR)	10	18.70 USD
LDR WP 26 TIG BOYUN	10	9.47 USD
LDR WP 26F TIG BOYUN (BÜKÜLEBİLİR)	10	12.33 USD

MIG / MAG Kaynak Torç Tetikleri

ÜRÜN		FİYAT
LDR MIG TETİK- İTHAL	50	1.41 USD
LDR MIG TETİK (YERLİ)	50	1.48 USD

MIG / MAG Nipelleri

ÜRÜN		FİYAT
LDR 501 AKIM KABLOSU SIKMA YÜZÜĞÜ	10	0.60 USD
LDR 36/38 AKIM KABLOSU SIKMA YÜZÜĞÜ	10	1.63 USD
LDR 15/24/25 AKIM KABLOSU SIKMA YÜZÜĞÜ	10	1.63 USD
LDR 501 AKIM KABLOSU BOYUN NİPELİ - ERKEK	10	2.07 USD
LDR 501 AKIM KABLOSU DİP ADAPTÖR RAKORU - DIŞI	10	2.07 USD
LDR POLYAMİD HORTUM NİPELİ KONTRA SOMUNU (MIOXI)	10	0.63 USD

Kaynak ve Şase Penseleri

ÜRÜN		FİYAT
300A ELEKTROD PENSESİ	10	7.40 USD
500A ELEKTROD PENSESİ	10	11.85 USD
300A TOPRAKLAMA PENSESİ	10	4.45 USD
500A TOPRAKLAMA PENSESİ	10	7.40 USD

TIG Kaynak Torçları Elektrod Sıkıcıları

ÜRÜN		FİYAT
UZUN / ELEKTROD SIKICI (17/18/26)	10	0.88 USD
ORTA/ ELEKTROD SIKICI (17/18/26)	10	0.82 USD
KISA/ ELEKTROD SIKICI (17/18/26)	10	0.76 USD

TIG Kaynak Torçları

ÜRÜN		FİYAT
LDR 17 TIG TORÇ (4MT-150A) DERİ KILIFLI	5	100.65 USD
LDR 17 TIG TORÇ (4MT-150A) EKO. / 16mm KAYNAK KABLO	5	71.05 USD
LDR 17 TIG TORÇ (8MT-150A) DERİ KILIFLI	5	140.60 USD
LDR 17 TIG TORÇ (8MT-150A) EKO. / 16mm KAYNAK KABLO	5	100.65 USD
LDR 17F TIG TORÇ (4MT-150A) DERİ KILIFLI - BÜKÜLEBİLİR	5	106.55 USD
LDR 17V TIG TORÇ (4MT-150A) - VANALI	5	74.00 USD
LDR 17V TIG TORÇ (8MT-150A) - VANALI	5	108.00 USD
LDR 18 TIG TORÇ (4MT-350A)/W DERİ KILIFLI	5	129.00 USD
LDR 18 TIG TORÇ (8MT-350A)/W DERİ KILIFLI	5	167.25 USD
LDR 18F TIG TORÇ (4MT-350A)/W DERİ KILIFLI - BÜKÜLEBİLİR	5	136.15 USD
LDR 18F TIG TORÇ (8MT-350A)/W DERİ KILIFLI - BÜKÜLEBİLİR	5	176.15 USD
LDR 18V TIG TORÇ (4MT-350A)/W - VANALI	5	105.10 USD
LDR 18V TIG TORÇ (8MT-350A)/W - VANALI	5	148.00 USD
LDR 26 TIG TORÇ (4MT-200A) DERİ KILIFLI	5	115.45 USD
LDR 26 TIG TORÇ (4MT-200A) EKO. / 25mm KAYNAK KABLO	5	85.85 USD
LDR 26 TIG TORÇ (8MT-200A) DERİ KILIFLI	5	153.95 USD
LDR 26 TIG TORÇ (8MT-200A) EKO. / 25mm KAYNAK KABLO	5	130.25 USD
LDR 26F TIG TORÇ (4MT-200A) DERİ KILIFLI - BÜKÜLEBİLİR	5	116.95 USD
LDR 26F TIG TORÇ (8MT-200A) DERİ KILIFLI - BÜKÜLEBİLİR	5	153.95 USD
LDR 26V TIG TORÇ (4MT-200A) VANALI	5	84.40 USD
LDR 26V TIG TORÇ (8MT-200A) VANALI	5	130.25 USD

TIG Kaynak Torçları Gaz Lensleri

ÜRÜN		FİYAT
GAZ LENS 2,4M M {17 /18/26}	10	4.85 USD
GAZ LENS 3,2MM {17/18/26}	10	4.85 USD
GAZ LENS 1,6MM (9/20)	10	3.70 USD
GAZ LENS 2,0MM (9/20)	10	3.70 USD
GAZ LENS 2,4MM (9/20)	10	3.70 USD
GAZ LENS 3,2MM (9/20)	10	3.70 USD
GAZ LENS 4,0MM (9/20)	10	3.70 USD
GAZ LENS 1,6MM {17/18/26} LARGE	10	8.15 USD
GAZ LENS 2,0MM {17/18/26} LARGE	10	8.15 USD
GAZ LENS 2,4MM {17/18/26} LARGE	10	8.15 USD
GAZ LENS 3,2MM {17/18/26} LARGE	10	8.15 USD
GAZ LENS 4,0MM {17/18/26} LARGE	10	8.15 USD
GAZ LENS 1,6MM (9/20) EKSTR A LARGE	10	9.35 USD

TIG Kaynak Torçları Pens Tutucuları

ÜRÜN		FİYAT
COLLET BODY {17/18/26} 2,0MM {10N24M}	10	1.15 USD
COLLET BODY (17 /18/26) 2,4M M (10N32)	10	1.15 USD
COLLET BODY {17 /18/26} 3,2M M {10N28}	10	1.15 USD
COLLET BODY (9/20) 2,0MM {70067WT}	10	1.05 USD
COLLET BODY {9/20} 2,4MM {13N28}	10	1.05 USD
COLLET BODY (9/20) 3,2MM (13N29)	10	1.05 USD

Su Jakları - Gaz Nipelileri

ÜRÜN		FİYAT
LDR SU JAKI (DİŞİ) 6MM MAVİ-KIRMIZI-NÖTRN	20	4.45 USD
LDR SU JAKI (DİŞİ) 8MM MAVİ-KIRMIZI-NÖTRN	20	4.45 USD
LDR SU JAKI (DİŞİ) 10MM MAVİ-KIRMIZI-NÖTRN	20	4.45 USD
LDR SU JAKI (DİŞİ) 1/8 MAVİ-KIRMIZI-NÖTRN	20	4.15 USD
LDR SU JAKI (ERKEK) 5MM - 6MM - 8MM	20	0.70 USD
LDR SÖKÜLEBİLİR SU JAKI ARKA BAĞLANTI NİPERLİ 6MM -8MM -10MM	20	2.30 USD

TIG Kaynak Torçları Seramik Nozulları

ÜRÜN		FİYAT
10 N 50 SERAMİK NOZUL N.4 (17/18/26)	10	0.65 USD
10 N 49 SERAMİK NOZUL N.5 (17/18/26)	10	0.65 USD
10 N 48 SERAMİK NOZUL N.6 (17/18/26)	10	0.65 USD
10 N 47 SERAMİK NOZUL N.7 (17 /18/26)	10	0.65 USD
10 N 46 SERAMİK NOZUL N.8 (17/18/26)	10	0.65 USD
10 N 45 SERAMİK NOZUL N.10 (17/18/26)	10	0.65 USD
10 N 44 SERAMİK NOZUL N.12 (17/18/26)	10	0.65 USD
10 N 50 L SERAMİK NOZUL N.4 (17 /18/26) UZUN	10	1.15 USD
10 N 49 L SERAMİK NOZUL N.5 (17 /18/26) UZUN	10	1.15 USD
10 N 48 L SERAMİK NOZUL N.6 (17 /18/26) UZUN	10	1.15 USD
10 N 47 L SERAMİK NOZUL N.7 (17/18/26) UZUN	10	1.15 USD
10 N 46 L SERAMİK NOZUL N.8 (17 /18/26) UZUN	10	1.15 USD
13 N 07 SERAMİK NOZUL N.3 (9/20)	10	0.50 USD
13 N 08 SERAMİK NOZUL N.4 (9/20)	10	0.50 USD
13 N 09 SERAMİK NOZUL N.5 (9/20)	10	0.50 USD
13 N 10 SERAMİK NOZUL N.6 (9/20)	10	0.50 USD
13 N 11 SERAMİK NOZUL N.7 (9/20)	10	0.50 USD
13 N 12 SERAMİK NOZUL N.8 (9/20)	10	0.50 USD
13 N 13 SERAMİK NOZUL N.10 (9/20)	10	0.50 USD
13 N 14 SERAMİK NOZUL N.11 (9/20)	10	0.50 USD
13 N 07 L SERAMİK NOZUL N.3 (9/20) UZUN	10	1.11 USD
13 N 08 L SERAMİK NOZUL N.4 (9/20) UZUN	10	1.11 USD
13 N 09 L SERAMİK NOZUL N.5 (9/20) UZUN	10	1.11 USD

Tetik Soketleri

ÜRÜN		FİYAT
2 PİNLİ SOKET (DİŞİ)	5	2.10 USD
2 PİNLİ SOKET (ERKEK)	5	11.90 USD
3 PİNLİ SOKET (ERKEK)	5	10.93 USD
5 PİNLİ SOKET (ERKEK) LINCOLN	5	13.32 USD
2 PİNLİ HYLONG (ERKEK) SOKET	5	15.54 USD
2 PİNLİ HYLONG (DİŞİ) SOKET	5	16.28 USD



**SUPER
EGO**



Elektrikli Boru Pafta Takımı



Ø
1/2" - 1 1/4"

BSPT

6 Kg

1010
W



BOYUTLAR		FİYAT
1/2"-1.1/4"	1	735.00 EURO

Elektrikli Boru Pafta Takımı



Ø
1/2" - 2"

BSPT

6 Kg

1010
W



BOYUTLAR		FİYAT
1/2"-2"	1	945.00 EURO

Yedek Pafta Kafaları



BOYUTLAR		FİYAT
1/2"	32	35.80 EURO
3/4"	32	35.80 EURO
1"	32	41.50 EURO
1.1/4"	20	45.60 EURO
1.1/2"	10	73.90 EURO
2"	10	73.90 EURO

Boru Pafta Takımı

1/2 - 1" Tek kol
1/2" Yedek kafa
3/4" Yedek kafa
1" Yedek kafa



BOYUTLAR		FİYAT
1/2"-1"	4	157.00 EURO

Boru Pafta Takımı

1/2 - 1 1/4" Tek kol
1/2" Yedek kafa
3/4" Yedek kafa
1" Yedek kafa
1 1/4" Yedek kafa



BOYUTLAR		FİYAT
1/2"-1 1/4"	4	202.00 EURO

Boru Pafta Takımı

1/2 - 2" Tek kol
1/2" Yedek kafa
3/4" Yedek kafa
1" Yedek kafa
1 1/4" Yedek kafa
1 1/2" Yedek kafa
2" Yedek kafa
Adaptör



BOYUTLAR		FİYAT
1/2"-2"	1	415.00 EURO

Tek Kol



BOYUTLAR		FİYAT
1.1/4"	15	57.00 EURO
2"	10	92.00 EURO

Kol Küçültme Adaptörü



BOYUTLAR		FİYAT
1.1/4"	1	21.50 EURO

1 1/4" Kol Yedek Dişlisi



BOYUTLAR		FİYAT
1.1/4"	1	19.00 EURO

Havşa Açma Seti
Boru Kesicili

BOYUTLAR		FİYAT
4 - 14 mm.	1	93.50 EURO

Torklu Havşa Makinası



YENİ



BOYUTLAR		FİYAT
3 - 19 mm - 1/8 - 3/4	1	139.00 EURO

Yedek Dişli Tarak



BOYUTLAR		FİYAT
1/2"	4	25.00 EURO
3/4"	4	25.00 EURO
1"	4	25.00 EURO
1.1/4"	4	25.00 EURO
1.1/2"	4	39.70 EURO
2"	4	39.70 EURO

Mini Bakır Boru Kesici Pro 722



BOYUTLAR		FIYAT
3 - 22 mm.	4	13.30 EURO

Bakır Boru Kesici Pro 725



BOYUTLAR		FIYAT
3 - 30 mm.	4	16.80 EURO

Teleskopik Bakır Boru Kesiciler



YENİ

MODEL	BOYUTLAR		FIYAT
735	3 - 35 mm.	4	30.90 EURO
742	6 - 42 mm	4	35.50 EURO
750	6 - 67 mm	9	79.50 EURO
751 01 PVC boru kesici	50 - 127 mm	1	148.00 EURO
751 00 Bakır boru kesici	50 - 127 mm	1	148.00 EURO

Bakır Boru Kesici Bıçağı Pro 722 - 725 - 735 Modellerine Uygundur



BOYUTLAR		FIYAT
3 - 35 mm.	5	3.10 EURO

Zincirli Boru Anahtarları



YENİ

ÜRÜN ADI	FIYAT
1. 1/2" Zincirli boru anahtarı	53.80 EURO
2. 1/2" Zincirli boru anahtarı	99.60 EURO
4" Zincirli boru anahtarı	144.50 EURO
6" Zincirli boru anahtarı	269.50 EURO
8" Zincirli boru anahtarı	352.00 EURO
12" Zincirli boru anahtarı	655.00 EURO
Yedek zincir 2. 1/2"	36.00 EURO
Yedek zincir 4"	47.00 EURO
Yedek zincir 6"	151.00 EURO
Yedek zincir 8"	188.00 EURO
Yedek zincir 12"	262.00 EURO

PVC Boru Kesici 32 mm (Dar yerler için)



YENİ

BOYUTLAR		FİYAT
32 mm.	4	35.60 EURO

PVC Boru Kesici 42 mm



BOYUTLAR		FİYAT
42 mm.	10	41.50 EURO

PVC Boru Kesici 50 mm



BOYUTLAR		FİYAT
50 mm.	6	49.50 EURO

PVC Boru Kesici 63 mm



BOYUTLAR		FİYAT
63 mm.	6	59.60 EURO

PVC Boru Kesici 75 mm



BOYUTLAR		FİYAT
75 mm	1	121.00 EURO

Boru Kesici 1 1/4"



BOYUTLAR		FİYAT
1.1/4"	6	56.00 EURO

Boru Kesici 2"



BOYUTLAR		FİYAT
2"	6	69.60 EURO

Boru Kesici 4"



BOYUTLAR		FİYAT
4"	3	229.00 EURO

YENİ

Boru Kesici Yedek Bıçakları



BOYUTLAR		FİYAT
1.1/4"	5	6.80 EURO
2"	5	8.00 EURO
4"	3	14.70 EURO

YENİ

INOX Boru Kesici Bıçağı



BOYUTLAR		FİYAT
3 - 35 mm	5	6.40 EURO
2"	5	10.50 EURO

YENİ

Maşalı Boru Anahtarları



BOYUTLAR		FİYAT
1"	18	28.50 EURO
1. 1/2"	14	40.40 EURO
2"	10	66.00 EURO

Fort Pense



YENİ

MODEL	BOYUTLAR		FİYAT
522	10"	6	15.50 EURO
522	12"	6	22.90 EURO

Manuel Su Test Cihazları



RP 50 ÇİFTVANALI
 Basınç : 60 bar
 Bağlantı : R 1/2"
 Depo : 12 Litre
 Ağırlık : 8 kg

ÜRÜN	FİYAT
RP 50 Su Test Cihazı 0-60 bar	419.00 EURO

Universal Bakır Boru Kıvrma Aparatı



YENİ

ÜRÜN	FİYAT
Bakır boru kıvrma aparatı 6 - 8 - 10 mm	25.50 EURO
Bakır boru kıvrma aparatı 1/4" - 5/6" - 3/8"	33.50 EURO

Bakır Boru Kıvrma Aparatları



BOYUTLAR	FİYAT
6 mm	50.20 EURO
8 mm - 5/6	53.70 EURO
10 mm	62.90 EURO
12 mm	66.90 EURO
14 mm	82.30 EURO
15 mm	87.50 EURO
16 mm	90.00 EURO
18 mm	120.00 EURO

PRESSOL



Bohle



 **WOLF'S HEAD**



BAHCO



Gres Pompası

Kollu gres pompası 500 cc. Siboplu

18.00 EURO

10

**Havallı Gres Pompası
500 cc.****58.50 EURO**

10

Gres Pompa Hortumu ve Borusu

ÜRÜN	FİYAT
PRHO - 12656 GRES POMPA HORTUMU 30 CM.	3.37 EURO
PRHO - 12666 GRES POMPA HORTUMU 50 CM.	4.70 EURO
PRUC 4 Çeneli Gres Pompa Ucu	1.97 EURO

Basmalı Tip Gres Tabancası

KOD	ÜRÜN	FİYAT
PR12322	150 ml İnce Uçlu (Plastik)	10.55 EURO
PR12332	150 ml Gresollük Uçlu (Plastik)	12.15 EURO
PR12363	150 ml Çift Uçlu Gresollük ve İnce Uç (Metal)	20.35 EURO
PR12365	300 ml Çift Uçlu Gresollük ve İnce Uç (Metal)	26.70 EURO

Kova Tipi Gres Pompaları

KOD	ÜRÜN	FİYAT
PR17781	Mekanik Kollu İnce Yağ Pompası 8 Lt.	98.50 EURO
PR17786	Mekanik Kollu Gres Pompası 8 Lt.	98.50 EURO
PR17788	Mekanik Kollu Gres Pompası 12 Lt.	105.50 EURO
PR17790	Mekanik Kollu İnce Yağ Pompası 16 Lt. Tekerlekli	127.00 EURO
PR17792	Mekanik Kollu Gres Pompası 16 Lt. Tekerlekli	127.00 EURO

Plastik Yağdanlık



ÖLÇÜ		FİYAT
300 cc	72	4.35 USD
500 cc	60	5.00 USD
700 cc	48	5.25 USD
700 cc Uzun	48	5.75 USD

Plastik gövdeli

Metal Yağdanlık



ÖLÇÜ		FİYAT
300 cc	60	5.25 USD
500 cc	60	6.00 USD

Metal gövdeli

Süzgeçli Plastik Huni



ÖLÇÜ		FİYAT
Ø 160 mm	30	3.25 USD

Litre Kapları



YENİ

ÖLÇÜ		FİYAT
0,5 Litre	24	6.20 USD
1,0 Litre	24	7.40 USD
2,0 Litre	12	9.10 USD
3,0 Litre	12	10.25 USD
5,0 Litre	6	12.00 USD
10,0 Litre	6	18.70 USD

Huniler



YENİ

ÖLÇÜ		FİYAT
10 cm	24	3.75 USD
15 cm	24	4.60 USD
20 cm	12	5.50 USD
25 cm	12	6.80 USD
30 cm	6	9.95 USD
Dirsekli	6	11.00 USD

Silberschnitt Cam Elması



ÜRÜN		DÜZİNE FİYAT
Silberschnitt Cam Elması	50 düzine	66.00 EURO

Jobo Cam Elması



ÜRÜN		DÜZİNE FİYAT
Jobo Cam Elması	100 düzine	27.00 EURO

Silberschnitt Cam Elmas Ucu



ÜRÜN		DÜZİNE FİYAT
Silberschnitt Cam Elmas Ucu B0102.0	120 düzine	6.00 EURO
Silberschnitt Cam Elmas Ucu B0102.1	120 düzine	8.00 EURO

Silberschnitt Hard Metal Cam Elması Ağaç Saplı



ÜRÜN		FİYAT
Hard Metal Cam Elması Ağaç Saplı	10	15.40 EURO

Silberschnitt Hard Metal Cam Elması Plastik Saplı



ÜRÜN		FİYAT
Hard Metal Cam Elması Plastik Saplı	10	18.40 EURO

Silberschnitt Gazlı Cam Elması Geniş Kafa Metal



ÜRÜN	FIYAT
Gazlı Cam Elması Geniş Kafa Metal	27.00 EURO
Gazlı Cam Elması Dar Kafa Metal	29.50 EURO

Silberschnitt Gazlı Cam Elması Geniş Kafa Plastik



ÜRÜN	FIYAT
Gazlı Cam Elması Geniş Kafa Plastik	25.50 EURO
Gazlı Cam Elması Dar Kafa Plastik	30.00 EURO

Silberschnitt Gazlı Cam Elması Ucu Geniş/Dar Kafa



ÜRÜN	FIYAT
Gazlı Cam Elması Ucu Geniş Kafa	16.60 EURO
Gazlı Cam Elması Ucu Dar Kafa	19.50 EURO

Silberschnitt Cam Kırma Penseleri



ÜRÜN		FIYAT
Cam Kırma Pensesi 180 mm	6	53.00 EURO
Cam Kırma Pensesi 200 mm	6	54.00 EURO

Tekli Plastik Gövdeli Vantuz

Taşıma kapasitesi: 20 kg
Ağırlık: 330 gr
Çap: 123 mm



12.30 USD



Tekli Alüminyum Gövdeli Vantuz

Taşıma kapasitesi: 30 kg
Ağırlık: 480 gr
Çap: 123 mm



23.70 USD



Tekli Pompalı Plastik Gövde Vantuz

Taşıma kapasitesi: 85 kg
Çap: 200 mm



73.80 USD



Oto Kapı Camı Tutucu Vantuzu

2'li takım
Çap: 78 mm



13.50 USD



Esnek Kollu Oto Cam Vantuzu

Esnek ve yumuşak izoleli kol
Kol boyu 42 cm
Çap: 117 mm



50.00 USD



2 li Plastik Gövdeli Vantuz

Taşıma kapasitesi: 35 kg
Ağırlık: 560 gr
Çap: 117 mm



23.40 USD



2 li Plastik Gövdeli Vantuz

Hareketli kol
Taşıma kapasitesi: 30 kg
Ağırlık: 580 gr
Çap: 123 mm



30.00 USD



2 li Alüminyum Gövdeli Vantuz

Taşıma kapasitesi: 50 kg
Ağırlık: 560 gr
Çap: 117 mm



40.00 USD



3 lü Plastik Gövdeli Vantuz

Taşıma kapasitesi: 70 kg
Ağırlık: 800 gr
Çap: 117 mm



33.00 USD



3 lü Alüminyum Gövdeli Vantuz

Taşıma kapasitesi: 100 kg
Ağırlık: 1410 gr
Çap: 123 mm
Krom kaplama



68.00 USD



Üç Köşe Eğe



BOYUTLAR		FİYAT
Slim 4	10	4.05 EURO
Slim 4.5	10	4.05 EURO
Slim 5	10	4.05 EURO
Slim 6	10	4.05 EURO
Slim 7	10	5.70 EURO
Tapper 6	10	4.80 EURO
Tapper 7	10	5.70 EURO

Yassı Eğe Hand

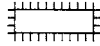

BOYUTLAR		FİYAT
Kalın 4	10	4.50 EURO
Kalın 6	10	4.80 EURO
Kalın 8	10	6.25 EURO
Kalın 10	10	8.15 EURO
Kalın 12	5	11.05 EURO
Orta 6	10	5.10 EURO
Orta 8	10	6.55 EURO
Orta 10	10	8.50 EURO
Orta 12	5	11.35 EURO
İnce 6	10	5.40 EURO
İnce 8	10	6.65 EURO
İnce 10	10	8.70 EURO
İnce 12	5	11.65 EURO

Mil Eğe

Bir Kenarı Yuvarlak

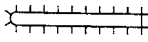

BOYUTLAR		FİYAT
6	10	5.90 EURO
8	10	7.70 EURO
10	10	9.50 EURO
12	5	13.10 EURO

Ağaç Törpü



BOYUTLAR		FİYAT
10	10	13.20 EURO

Yarım Yuvarlak Eğe



BOYUTLAR		FİYAT
Kalın 6	10	7.70 EURO
Kalın 8	10	9.50 EURO
Kalın 10	10	11.50 EURO
Kalın 12	5	17.75 EURO
Orta 6	10	7.85 EURO
Orta 8	10	9.70 EURO
Orta 10	10	12.00 EURO
İnce 6	10	8.05 EURO
İnce 8	10	9.90 EURO
İnce 10	10	12.25 EURO

Yuvarlak Eğe



BOYUTLAR		FİYAT
Kalın 6	10	5.10 EURO
Kalın 8	10	6.05 EURO
Kalın 10	10	7.30 EURO
Kalın 12	5	10.20 EURO
Orta 6	10	5.40 EURO
Orta 8	10	6.40 EURO
Orta 10	10	8.20 EURO

Anahtarcı Ara Egesi

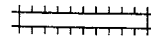

BOYUTLAR		FİYAT
Kalın 4	10	5.05 EURO
Kalın 6	10	5.40 EURO
Kalın 8	10	7.70 EURO
Orta 4	10	5.15 EURO
Orta 6	10	6.05 EURO
Orta 8	10	8.60 EURO
İnce 6	10	6.65 EURO

Bimetal Demir Testere Laması
300 mm

BOYUTLAR		FİYAT
18 Diş	100	1.45 EURO
24 Diş	100	1.45 EURO



Saatçi Kalıpcı Egesi Yassı Hand

8.00 EURO

Saatçi Kalıpcı Egesi Üç Köşe

9.20 EURO

Saatçi Kalıpcı Egesi Dört Köşe

9.20 EURO

Saatçi Kalıpcı Egesi Yuvarlak

8.00 EURO

Saatçi Kalıpcı Egesi Yarım Yuvarlak

10.50 EURO

Saatçi Kalıpcı Egesi Bıçak

9.30 EURO

Saplı Ege Takım 5'li 8"

51.60 EURO



Saplı Ege Takım 5'li 10"

60.00 EURO



Saatçi Kalıpcı Egesi 6'lı Takım

51.60 EURO

Demir Testere Kolu 319 Modeli
Bimetal 24 Diş

36.00 EURO



Motor Testere Egesi



Mora Bıçak 2444 Modeli Kılıflı

10.00 EURO



BOYUTLAR		FİYAT
5/32	36	1.25 EURO
3/16	36	1.25 EURO
7/32	36	1.25 EURO



Myros Special



Genel amaçlı kullanım
Sertleştirilmiş Eko-Pro model

MODEL		FİYAT
300 x 25 x 0,65 CR 24 TPI	72	0.27 EURO
300 x 25 x 0,65 CR 18 TPI	72	0.27 EURO

Kobalt Testere Ağzı



Çok sert metaller için
Paslanmaz çelik vb. ekstra sertleştirilmiş
metallerin kesimi için uygundur.

MODEL		FİYAT
300 x 13 x 0,60 COBALT 24 TPI	100	0.95 EURO
300 x 13 x 0,60 COBALT 18 TPI	100	0.95 EURO

Karbon 2 Ağızlı Testere Ağzı



DIY İşlemler
Yumuşak metaller, plastik vb.

MODEL		FİYAT
300 x 25 x 0,65 CARBON 24/14 TPI	50	0.56 EURO

High Carbon Steel Testere Ağzı



DIY İşlemler
Yumuşak metaller, plastik vb.

MODEL		FİYAT
300 x 13 x 0,65 HCS 24 TPI	100	0.43 EURO
300 x 13 x 0,60 HCS 18 TPI	100	0.43 EURO

Bimetal Mini El Testeresi Yedek Testere Ağzı



Bimetal alaşımlı
Sert metallerin kesimi için
Ulaşılması zor alanlar için ideal tasarım

MODEL		FİYAT
300 x 13 x 0,60 BIMETAL 24 TPI	10	4.35 EURO
300 x 13 x 0,60 YEDEK TESTERE AĞZI	100	0.90 EURO

KEIL Beton Matkap Uçları



NORMAL TİP

BOYUTLAR		FIYAT
4 mm	300	0.80 EURO
5 mm	300	0.84 EURO
6 mm	250	0.87 EURO
7 mm	200	1.00 EURO
8 mm	150	1.13 EURO
9 mm	100	1.17 EURO
10 mm	100	1.41 EURO
12 mm	50	2.16 EURO
14 mm	50	2.77 EURO
16 mm	50	3.91 EURO
18 mm	20	5.65 EURO
20 mm	20	6.00 EURO



KEIL Beton Matkap Uçları SDS Tip

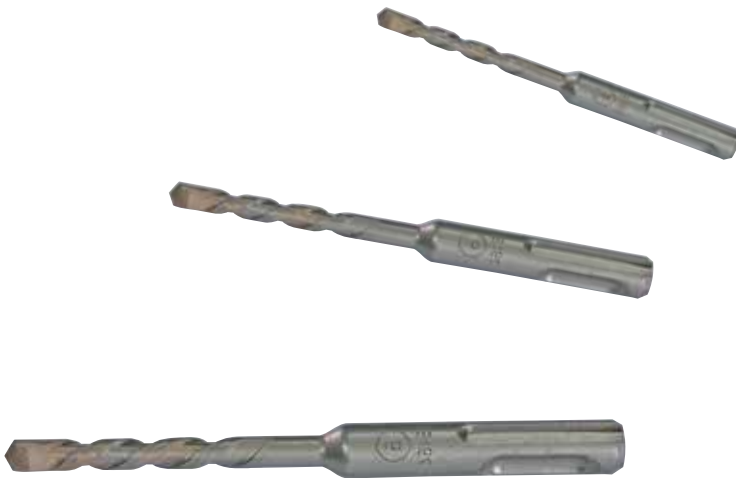

S.D.S. TİP

BOYUTLAR		FIYAT
9/110 mm	50	2.00 EURO
10/110 mm	40	1.45 EURO



Kombine Pense İzoleli 160 mm

BOYUTLAR		FİYAT
160 mm	120	5.00 USD
180 mm	120	5.00 USD



Kargaburun İzoleli 160 mm

5.00 USD

 120



Yan Keski İzoleli 160 mm

5.00 USD

 120



Fort Pense 250 mm

8.50 USD

 60



Maşalı Boru Anahtarı



BOYUTLAR		FİYAT
1"	12	14.00 USD
1 1/2"	12	23.00 USD
2"	12	26.00 USD

Elektrik Kontrol Kalemı

Darbelere dayanıklı polikarbonat gövde
Sarı iletken kapsül içeren ampul
Islıl işlem görmüş çelik uçlar



ÜRÜN		FİYAT
Düz	576	0.85 USD
Yıldız	576	0.85 USD

Çok Amaçlı Yaylı Makas

5.50 USD

 30



Tornavida Takımı 5 li

1 x 80 yıldız
2 x 100 yıldız
3 x 75 düz
4 x 100 düz
5.5 x 125 düz

3.00 USD

 20



Allen Takım 9 Parça Kısa Tip



BOYUTLAR		FİYAT
9 parça düz	100	5.30 USD
9 parça torx	100	5.75 USD

Allen Takım 9 Parça Uzun Tip



BOYUTLAR		FİYAT
9 parça düz	100	6.90 USD
9 parça torx	100	7.70 USD

Taşlama Anahtarları



BOYUTLAR		FİYAT
115 mm	100	2.20 USD
180 mm	100	2.70 USD

İskarpela Takımı 4'lü 6 mm - 12 mm - 18 mm - 24 mm



16.50 USD

 24

Eğre Seti 5'li Plastik Saplı



11.50 USD

 40

İskarpela Ergonomik Saplı



BOYUTLAR		FİYAT
14 mm	12	4.50 USD
16 mm	12	4.50 USD
18 mm	12	4.50 USD
20 mm	12	4.50 USD

Eğre Sapı



ÖLÇÜ		FİYAT
Düz	600	0.35 USD
Motorcu	600	0.35 USD

Taş Seti 10 Parça Renkli



5.50 USD

 10

 50

Alüminyum Şablon Cetveli

12.00 USD



20

YENİ



Bits Adaptör Takımı 3 lü

7.00 USD



20

YENİ



Köşe Vidalama Matkap Ucu

6.00 USD



25

YENİ



Hasarlı Vida Sökücüler

MODEL		FİYAT
4 parçalı	25	4.00 USD
6 parçalı	25	5.00 USD

YENİ



Kalıplama 250 mm

15.00 USD



20

YENİ



Matkap Uçlu Ağaç Törpüsü 5 Parça



YENİ

5.25 USD



50

Matkap Uçlu Eğe Takımı 5 Parça



YENİ

6.25 USD



50

Matkap Ucu Seti 16 Parça



YENİ

8.50 USD



25

Freze Bıçak Takımları



ÖLÇÜ		FİYAT
6 mm	10	20.00 USD
12 mm	10	25.00 USD

Alüminyum Gövdeli Vantuz 2 li
Çap: 118 mm

YENİ

20.00 USD



25

Pompaı Plastik Gövdeli Vantuz
Çap: 200 mm Çantalı

YENİ

65.00 USD





25

Mini İşkence

YENİ



ÖLÇÜ			FİYAT
50 X 150 mm	10	60	5.90 USD
50 X 200 mm	10	60	6.10 USD
50 X 300 mm	10	60	6.40 USD
50 X 400 mm	10	60	7.10 USD
50 X 500 mm	10	40	7.90 USD
50 X 600 mm	10	40	8.30 USD
80 X 200 mm	6	36	8.80 USD
80 X 250 mm	6	36	9.05 USD
80 X 300 mm	6	36	9.30 USD
80 X 400 mm	6	24	9.85 USD
80 X 500 mm	6	24	10.45 USD
80 X 600 mm	6	24	11.05 USD

Mini Mengene



5.50 USD

 100



Alüminyum Mengene

YENİ



ÖLÇÜ		FİYAT
50 mm	48	9.50 USD
60 mm	48	11.50 USD

Ağaç Saplı Çekiçler



MODEL		FİYAT
100 gr	60	1.25 USD
200 gr	60	1.90 USD
300 gr	60	2.25 USD
500 gr	48	2.95 USD
1000 gr	24	4.90 USD
1500 gr	12	6.15 USD
2000 gr	12	7.50 USD

Ağaç Saplı Çatal Çekiçler



MODEL		FİYAT
300 gr	60	??? USD
600 gr	60	??? USD

Ağaç Saplı Keser



MODEL		FİYAT
300 gr	60	3.00 USD

Ağaç Saplı Çapalar



MODEL		FİYAT
Çatal Çapa	60	2.00 USD
Üçgen Çapa	60	3.00 USD
Ay Çapa	60	4.00 USD

Ağaç Saplı Lastik Tokmak



ÖLÇÜ		FİYAT
Ø 50	60	1.80 USD
Ø 60	48	2.10 USD

Vidalı Tokmak
Plastik

ÖLÇÜ		FİYAT
Ø 40	48	3.50 USD
Ø 50	36	4.00 USD

Vidalı Tokmak
Ağaç Saplı

ÖLÇÜ		FİYAT
Ø 30	60	4.10 USD
Ø 40	48	5.40 USD
Ø 50	36	7.50 USD

Bordür Tokmağı



ÖLÇÜ		FİYAT
Ø 95	12	8.00 USD

Vidalı Tokmak Yedeği



ÖLÇÜ		FİYAT
Ø 30	100	0.85 USD
Ø 40	100	1.10 USD
Ø 50	100	1.25 USD





GFB





Inox Kesici Taş



KOD	EBAT			FİYAT
2350	115 x 1,0 x 22,23	50	600	0.32 USD
2350-1	125 x 1,0 x 22,23	50	600	0.44 USD
2351	180 x 1,6 x 22,23	50	200	0.85 USD



Metal Kesme Taş



KOD	EBAT			FİYAT
2355	115 x 2,5 x 22,23	25	200	0.53 USD
2356	180 x 3,0 x 22,23	25	100	1.04 USD
2357	230 x 3,0 x 22,23	25	50	1.50 USD
2358	300 x 3,0 x 25,40	5	25	2.70 USD
2359	355 x 3,0 x 25,40	5	25	3.30 USD

Metal Taşlama Taşı



KOD	EBAT			FİYAT
2360	115 x 6 x 22,23	10	100	0.82 USD
2361	180 x 8 x 22,23	10	50	2.20 USD



Zirkonyum Flap Disk Zımpara



KOD	EBAT			FİYAT
2321	115 mm 40 Kum	10	200	0.91 USD
2322	115 mm 60 Kum	10	200	0.91 USD
2323	115 mm 80 Kum	10	200	0.91 USD
2324	115 mm 100 Kum	10	200	0.91 USD
2325	115 mm 120 Kum	10	200	0.91 USD



Alüminyum Flap Disk Zımpara



KOD	EBAT			FİYAT
2326	115 mm 40 Kum	10	200	0.70 USD
2327	115 mm 60 Kum	10	200	0.70 USD
2328	115 mm 80 Kum	10	200	0.70 USD
2329	115 mm 100 Kum	10	200	0.70 USD
2330	115 mm 120 Kum	10	200	0.70 USD



HSS Matkap Ucu Siyah/Beyaz DIN 338



KOD	EBAT			FİYAT
1500	0,8 mm	500	10000	0,12 USD
1501	0,9 mm	500	10000	0,12 USD
1502	1,0 mm	500	5000	0,12 USD
1503	1,5 mm	200	5000	0,12 USD
1504	2,0 mm	200	5000	0,14 USD
1505	2,5 mm	250	5000	0,16 USD
1506	3,0 mm	250	5000	0,17 USD
1507	3,2 mm	200	4000	0,18 USD
1508	3,5 mm	200	4000	0,18 USD
1509	3,75 mm	100	5000	0,22 USD
1510	4,0 mm	200	4000	0,22 USD
1511	4,2 mm	200	4000	0,23 USD
1512	4,5 mm	150	3000	0,25 USD
1513	5,0 mm	100	2000	0,30 USD
1514	5,2 mm	100	2000	0,33 USD
1515	5,5 mm	100	2000	0,36 USD
1516	5,8 mm	100	2000	0,37 USD
1517	6,0 mm	100	2000	0,41 USD
1518	6,5 mm	50	1000	0,50 USD
1519	7,0 mm	50	1000	0,59 USD
1520	7,5 mm	80	800	0,64 USD
1521	8,0 mm	80	800	0,76 USD
1522	8,5 mm	60	600	0,86 USD

KOD	EBAT			FİYAT
1523	9,0 mm	60	600	0,97 USD
1524	9,5 mm	60	600	1,08 USD
1525	10,0 mm	50	500	1,20 USD
1526	10,5 mm	50	500	1,35 USD
1527	11,0 mm	50	300	1,53 USD
1528	11,5 mm	50	300	1,67 USD
1529	12,0 mm	50	300	1,93 USD
1530	12,5 mm	50	300	2,10 USD
1531	13,0 mm	50	300	2,30 USD
1532	13,5 mm	20	200	2,88 USD
1533	14,0 mm	20	200	3,10 USD
1534	14,5 mm	20	200	3,58 USD
1535	15,0 mm	20	200	3,78 USD
1536	15,5 mm	20	200	4,17 USD
1537	16,0 mm	10	100	4,60 USD
1538	16,5 mm	10	100	5,10 USD
1539	17,0 mm	10	100	5,30 USD
1540	17,5 mm	10	100	5,75 USD
1541	18,0 mm	10	100	6,18 USD
1542	18,5 mm	10	100	6,70 USD
1543	19,0 mm	10	100	7,00 USD
1544	19,5 mm	10	100	7,70 USD
1545	20,0 mm	10	100	7,95 USD

SOL MATKAP UCU

KOD	EBAT			FİYAT
1550	13,0 mm	20	200	9.50 USD

HSS Matkap Ucu (Titanyum Kaplı) DIN 338



KOD	EBAT	MCM		FİYAT
1600	1,0 mm	500	10000	0,15 USD
1601	1,5 mm	200	10000	0,15 USD
1602	2,0 mm	200	10000	0,17 USD
1603	2,5 mm	250	5000	0,21 USD
1604	3,0 mm	250	5000	0,25 USD
1605	3,2 mm	200	4000	0,28 USD
1606	3,5 mm	200	4000	0,31 USD
1607	4,0 mm	200	4000	0,35 USD
1608	4,2 mm	200	4000	0,40 USD
1609	4,5 mm	150	3000	0,43 USD
1610	5,0 mm	100	2000	0,48 USD
1611	5,5 mm	100	2000	0,58 USD
1612	6,0 mm	100	2000	0,65 USD
1613	6,5 mm	50	1000	0,80 USD
1614	7,0 mm	50	1000	0,90 USD
1615	7,5 mm	80	800	0,98 USD
1616	8,0 mm	80	800	1,18 USD
1617	8,5 mm	60	600	1,30 USD
1618	9,0 mm	60	500	1,47 USD
1619	9,5 mm	60	600	1,65 USD
1620	10,0 mm	50	500	1,95 USD

KOD	EBAT	MCM		FİYAT
1621	10,5 mm	50	500	2,10 USD
1622	11,0 mm	50	300	2,35 USD
1623	11,5 mm	50	300	2,55 USD
1624	12,0 mm	50	300	2,90 USD
1625	12,5 mm	50	300	3,10 USD
1626	13,0 mm	50	300	3,40 USD
1627	13,5 mm	20	200	4,10 USD
1628	14,0 mm	20	200	4,40 USD
1629	14,5 mm	20	200	5,00 USD
1630	15,0 mm	20	200	5,25 USD
1631	15,5 mm	20	200	6,00 USD
1632	16,0 mm	10	100	6,25 USD
1633	16,5 mm	10	100	7,00 USD
1634	17,0 mm	10	100	7,20 USD
1635	17,5 mm	10	100	7,80 USD
1636	18,0 mm	10	100	8,50 USD
1637	18,5 mm	10	100	9,00 USD
1638	19,0 mm	10	100	9,50 USD
1639	19,5 mm	10	100	10,40 USD
1640	20,0 mm	10	100	10,70 USD

Matkap Ucu Seti (Siyah - Beyaz)



YENİ

KOD	EBAT		FİYAT
1560	1-10 mm / 19 parça	25	14.00 USD
1561	1-13 mm / 25 parça	10	29.00 USD

HSS Süper Matkap Ucu DIN 338



KOD	EBAT	MCM		FİYAT
1700	2,5 mm	100	3000	0,29 USD
1701	3,0 mm	100	3000	0,50 USD
1702	3,2 mm	100	2000	0,58 USD
1703	3,5 mm	100	5000	0,58 USD
1704	4,0 mm	100	3000	0,64 USD
1705	4,2 mm	100	2000	0,70 USD
1706	4,5 mm	100	2000	0,79 USD
1707	5,0 mm	100	1000	0,90 USD
1708	5,5 mm	100	1000	1,05 USD
1709	6,0 mm	100	2200	1,22 USD
1710	6,5 mm	50	500	1,45 USD
1711	7,0 mm	50	500	1,72 USD
1712	7,5 mm	50	300	1,83 USD
1713	8,0 mm	50	500	2,20 USD
1714	8,5 mm	50	300	2,40 USD
1715	9,0 mm	50	300	2,82 USD
1716	9,5 mm	50	300	3,15 USD
1717	10,0 mm	50	600	3,60 USD
1718	10,5 mm	50	300	4,10 USD
1719	11,0 mm	50	150	4,60 USD
1720	11,5 mm	50	150	5,00 USD
1721	12,0 mm	50	150	5,58 USD
1722	12,5 mm	50	150	5,95 USD
1723	13,0 mm	50	150	6,35 USD
1724	13,5 mm	20	100	9,10 USD
1725	14,0 mm	20	100	9,25 USD
1726	14,5 mm	20	100	10,60 USD
1727	15,0 mm	20	100	11,00 USD
1728	15,5 mm	20	100	11,60 USD
1729	16,0 mm	20	100	12,50 USD
1730	16,5 mm	20	100	13,20 USD
1731	17,0 mm	10	100	13,75 USD
1732	17,5 mm	10	100	14,50 USD
1733	18,0 mm	10	100	14,80 USD
1734	18,5 mm	10	100	15,80 USD
1735	19,0 mm	10	100	16,50 USD
1736	19,5 mm	10	100	18,00 USD
1737	20,0 mm	10	100	18,50 USD

HSS Matkap Ucu (Uzun) DIN 340



KOD	EBAT	MCM		FİYAT
1745	1,0 mm	100	2000	0,33 USD
1746	1,5 mm	100	2000	0,33 USD
1747	2,0 mm	100	2000	0,36 USD
1748	2,5 mm	100	2000	0,38 USD
1749	3,0 mm	100	2000	0,53 USD
1750	3,5 mm	100	1000	0,58 USD
1751	4,0 mm	100	1000	0,62 USD
1752	4,2 mm	100	1000	0,64 USD
1753	4,5 mm	100	1000	0,73 USD
1754	5,0 mm	100	1000	0,85 USD
1755	5,5 mm	100	600	1,00 USD
1756	6,0 mm	100	600	1,08 USD
1757	6,5 mm	50	250	1,31 USD
1758	7,0 mm	50	250	1,52 USD
1759	7,5 mm	50	250	1,70 USD
1760	8,0 mm	50	200	1,92 USD
1761	8,5 mm	50	200	2,20 USD
1762	9,0 mm	50	250	2,45 USD
1763	9,5 mm	50	250	2,75 USD
1764	10,0 mm	20	300	3,10 USD

Matkap Ucu Seti (Bütün Beyaz)



YENİ

KOD	EBAT		FİYAT
1562	1-10 mm / 19 parça	10	33.00 USD
1563	1-13 mm / 25 parça	10	70.00 USD

HSE-E CO Altın Seri Matkap Ucu



KOD	EBAT			FİYAT
1798	0,7 mm	10	500	0,32 USD
1799	0,8 mm	10	500	0,32 USD
1800	1,0 mm	10	500	0,32 USD
1801	1,5 mm	10	500	0,38 USD
1802	2,0 mm	10	500	0,43 USD
1803	2,5 mm	10	500	0,60 USD
1804	3,0 mm	10	500	0,70 USD
1805	3,2 mm	10	500	0,80 USD
1806	3,3 mm	10	500	0,80 USD
1807	3,5 mm	10	500	0,90 USD
1808	4,0 mm	10	100	1,00 USD
1809	4,2 mm	10	150	1,10 USD
1810	4,3 mm	10	150	1,20 USD
1811	4,5 mm	10	100	1,20 USD
1812	5,0 mm	10	100	1,40 USD
1813	5,2 mm	10	100	1,50 USD
1814	5,5 mm	10	100	1,70 USD
1815	6,0 mm	10	100	2,00 USD
1816	6,5 mm	10	100	2,45 USD
1817	6,7 mm	10	100	3,00 USD
1818	6,8 mm	10	100	3,00 USD
1819	7,0 mm	10	100	3,00 USD
1820	7,5 mm	10	100	3,40 USD
1821	8,0 mm	10	100	4,00 USD
1822	8,5 mm	5	50	4,40 USD
1823	8,7 mm	5	50	5,20 USD

KOD	EBAT			FİYAT
1824	9,0 mm	5	50	5,20 USD
1825	9,5 mm	5	50	5,80 USD
1826	10,0 mm	5	50	6,70 USD
1827	10,2 mm	5	50	7,30 USD
1828	10,5 mm	5	50	7,30 USD
1829	11,0 mm	5	50	8,50 USD
1830	11,5 mm	5	50	9,20 USD
1831	12,0 mm	5	50	10,50 USD
1832	12,5 mm	5	50	11,50 USD
1833	13,0 mm	5	50	13,00 USD
1834	13,5 mm	1	1	18,50 USD
1835	14,0 mm	1	1	19,50 USD
1836	14,5 mm	1	1	22,00 USD
1837	15,0 mm	1	1	23,00 USD
1838	15,5 mm	1	1	24,50 USD
1839	16,0 mm	1	1	26,50 USD
1840	16,5 mm	1	1	28,00 USD
1841	17,0 mm	1	1	30,00 USD
1842	17,5 mm	1	1	32,00 USD
1843	18,0 mm	1	1	34,00 USD
1844	18,5 mm	1	1	37,00 USD
1845	19,0 mm	1	1	39,50 USD
1846	19,5 mm	1	1	42,00 USD
1847	20,0 mm	1	1	48,00 USD

Alaşımlı çelik, paslanmaz çelik ve krom için kullanıma uygundur. Dayanıklı plastik kutulardadır.
13 mm'den sonrası tek parça % 100 HSS olup, %5 Cobaltlıdır.

HSS Morslu Konik Matkap Ucu DIN 345



KOD	EBAT	FİYAT
1900	15,0 mm	7,70 USD
1901	15,5 mm	8,10 USD
1902	16,0 mm	8,50 USD
1903	16,5 mm	9,00 USD
1904	17,0 mm	9,10 USD
1905	17,5 mm	9,60 USD
1906	18,0 mm	9,80 USD
1907	18,5 mm	10,30 USD
1908	19,0 mm	10,60 USD
1909	19,5 mm	11,20 USD
1910	20,0 mm	11,50 USD
1911	20,5 mm	13,60 USD
1912	21,0 mm	14,00 USD
1913	21,5 mm	14,40 USD
1914	22,0 mm	14,60 USD
1915	22,5 mm	15,70 USD
1916	23,0 mm	16,10 USD
1917	23,5 mm	18,00 USD
1918	24,0 mm	18,20 USD
1919	24,5 mm	20,00 USD
1920	25,0 mm	20,20 USD
1921	25,5 mm	21,50 USD
1922	26,0 mm	21,70 USD
1923	26,5 mm	23,30 USD
1924	27,0 mm	23,60 USD
1925	27,5 mm	24,50 USD
1926	28,0 mm	25,00 USD
1927	28,5 mm	26,50 USD

KOD	EBAT	FİYAT
1928	29,0 mm	27,30 USD
1929	29,5 mm	27,50 USD
1930	30,0 mm	27,80 USD
1931	30,5 mm	33,70 USD
1932	31,0 mm	34,00 USD
1933	31,5 mm	37,70 USD
1934	32,0 mm	38,90 USD
1935	32,5 mm	40,10 USD
1936	33,0 mm	41,60 USD
1937	33,5 mm	43,90 USD
1938	34,0 mm	44,20 USD
1939	34,5 mm	46,30 USD
1940	35,0 mm	47,00 USD
1941	35,5 mm	49,30 USD
1942	36,0 mm	50,00 USD
1943	36,5 mm	53,00 USD
1944	37,0 mm	53,50 USD
1945	37,5 mm	55,50 USD
1946	38,0 mm	56,50 USD
1947	38,5 mm	60,00 USD
1948	39,0 mm	60,50 USD
1949	39,5 mm	61,00 USD
1950	40,0 mm	61,50 USD
1951	40,5 mm	69,00 USD
1952	41,0 mm	69,50 USD
1953	41,5 mm	70,00 USD
1954	42,0 mm	71,00 USD
1955	45,0 mm	80,00 USD
1956	50,0 mm	99,50 USD

SDS Plus Matkap Ucu (4 Kanallı)



Dayanıklı plastik poşetlerdedir.

KOD	EBAT		FİYAT
1960	4 x 110 mm	500	0,74 USD
1961	4 x 160 mm	400	0,80 USD
1962	5 x 110 mm	500	0,74 USD
1963	5 x 160 mm	400	0,80 USD
1964	5 x 210 mm	250	0,99 USD
1965	5,5 x 110 mm	500	0,74 USD
1966	5,5 x 160 mm	400	0,80 USD
1967	5,5 x 210 mm	250	1,03 USD
1968	6 x 110 mm	500	0,74 USD
1969	6 x 160 mm	400	0,80 USD
1970	6 x 210 mm	250	1,01 USD
1971	6 x 260 mm	200	1,12 USD
1972	6 x 310 mm	100	1,47 USD
1973	6,5 x 160 mm	400	0,84 USD
1974	6,5 x 210 mm	200	1,04 USD
1975	6,5 x 260 mm	200	1,17 USD
1976	7 x 110 mm	500	0,79 USD
1977	7 x 160 mm	400	0,91 USD
1978	7 x 210 mm	250	1,08 USD
1979	7 x 260 mm	200	1,30 USD
1980	8 x 110 mm	500	0,80 USD
1981	8 x 160 mm	400	0,93 USD
1982	8 x 210 mm	250	1,11 USD
1983	8 x 260 mm	200	1,30 USD
1984	8 x 350 mm	100	1,80 USD
1985	8 x 450 mm	100	2,60 USD

KOD	EBAT		FİYAT
1986	9 x 110 mm	500	0,91 USD
1987	9 x 160 mm	400	0,97 USD
1988	9 x 210 mm	250	1,18 USD
1989	10 x 110 mm	500	0,93 USD
1990	10 x 160 mm	400	1,01 USD
1991	10 x 210 mm	250	1,20 USD
1992	10 x 260 mm	200	1,41 USD
1993	10 x 310 mm	100	1,66 USD
1994	10 x 350 mm	100	1,89 USD
1995	10 x 450 mm	100	2,50 USD
1996	11 x 110 mm	500	0,99 USD
1997	11 x 160 mm	400	1,04 USD
1998	11 x 210 mm	250	1,30 USD
1999	12 x 110 mm	500	1,10 USD
2000	12 x 160 mm	400	1,13 USD
2001	12 x 210 mm	250	1,38 USD
2002	12 x 260 mm	200	1,60 USD
2003	12 x 310 mm	100	1,88 USD
2004	12 x 350 mm	100	2,04 USD
2005	12 x 450 mm	100	2,85 USD
2006	13 x 160 mm	300	1,47 USD
2007	13 x 210 mm	200	1,79 USD
2008	14 x 160 mm	300	1,53 USD
2009	14 x 210 mm	200	1,84 USD
2010	14 x 260 mm	130	2,05 USD
2011	14 x 310 mm	75	2,30 USD

SDS Plus Matkap Ucu (4 Kanallı)





KOD	EBAT		FİYAT
2012	14 x 350 mm	75	2,52 USD
2013	14 x 450 mm	75	3,13 USD
2014	15 x 160 mm	250	1,98 USD
2015	15 x 210 mm	150	2,21 USD
2016	16 x 160 mm	250	1,98 USD
2017	16 x 210 mm	150	2,22 USD
2018	16 x 260 mm	120	2,50 USD
2019	16 x 310 mm	80	2,89 USD
2020	16 x 350 mm	80	3,10 USD
2021	16 x 450 mm	80	3,86 USD
2021-1	17 x 210 mm	100	2,90 USD
2022	18 x 210 mm	100	3,00 USD
2023	18 x 260 mm	100	3,30 USD
2024	18 x 310 mm	80	3,69 USD
2025	18 x 350 mm	80	4,05 USD
2026	18 x 450 mm	80	4,90 USD
2027	20 x 210 mm	100	3,74 USD
2028	20 x 260 mm	100	4,50 USD
2029	20 x 310 mm	50	4,65 USD
2030	20 x 350 mm	50	5,10 USD
2031	20 x 450 mm	50	6,30 USD
2032	22 x 350 mm	50	6,05 USD
2033	22 x 450 mm	50	7,10 USD
2034	24 x 350 mm	50	7,35 USD
2035	24 x 450 mm	40	9,00 USD
2036	26 x 450 mm	40	10,50 USD
2037	28 x 450 mm	25	12,40 USD

KOD	EBAT		FİYAT
2040	10 x 600 mm	50	4,00 USD
2041	12 x 600 mm	50	4,15 USD
2042	14x 600 mm	50	4,80 USD
2043	16 x 600 mm	50	5,90 USD
2044	18 x 600 mm	40	7,00 USD
2045	20 x 600 mm	40	8,95 USD
2046	22 x 600 mm	50	10,50 USD
2047	24 x 600 mm	40	12,80 USD
2048	26 x 600 mm	20	14,15 USD
2049	28 x 600 mm	20	16,00 USD
2050	30 x 600 mm	20	20,00 USD
2051	10 x 800 mm	50	5,75 USD
2052	12 x 800 mm	50	5,75 USD
2053	14x 800 mm	50	6,50 USD
2054	16 x 800 mm	50	8,15 USD
2055	18 x 800 mm	50	9,60 USD
2056	20 x 800 mm	25	11,85 USD
2057	22 x 800 mm	25	13,30 USD
2058	24 x 800 mm	25	16,60 USD
2059	26 x 800 mm	25	18,40 USD
2060	28 x 800 mm	25	20,00 USD
2061	30 x 800 mm	10	25,00 USD
2062	10 x 1000 mm	25	7,50 USD
2063	12 x 1000 mm	25	7,70 USD
2064	14x 1000 mm	25	8,30 USD
2065	16 x 1000 mm	20	10,40 USD
2066	18 x 1000 mm	20	12,50 USD
2067	20 x 1000 mm	15	15,00 USD
2068	22 x 1000 mm	10	17,00 USD
2069	24 x 1000 mm	10	21,90 USD
2070	26 x 1000 mm	10	24,00 USD
2071	28 x 1000 mm	10	26,00 USD
2072	30 x 1000 mm	10	33,80 USD

4 Elmaslı SDS Plus Matkap Ucu





KOD	EBAT		FİYAT
2075	5 x 160 mm	200	1,03 USD
2076	5 x 210 mm	200	1,15 USD
2077	6 x 160 mm	200	1,03 USD
2078	6 x 210 mm	200	1,15 USD
2079	6,5 x 210 mm	200	1,15 USD
2080	7 x 160 mm	200	1,20 USD
2081	7 x 210 mm	200	1,38 USD
2082	8 x 160 mm	200	1,23 USD
2083	8 x 210 mm	200	1,38 USD
2084	9 x 160 mm	200	1,35 USD
2085	9 x 210 mm	200	1,58 USD
2086	10 x 160 mm	200	1,34 USD

KOD	EBAT		FİYAT
2087	10 x 210 mm	200	1,55 USD
2088	11 x 160 mm	200	1,65 USD
2089	11 x 210 mm	200	1,82 USD
2090	12 x 160 mm	200	1,65 USD
2091	12 x 210 mm	200	1,83 USD
2092	14 x 160 mm	200	2,12 USD
2093	14 x 210 mm	200	2,30 USD
2094	16 x 160 mm	100	2,65 USD
2095	16 x 210 mm	100	2,87 USD
2096	18 x 210 mm	100	3,87 USD
2097	20 x 210 mm	100	4,75 USD

Plastik askılıklardadır.

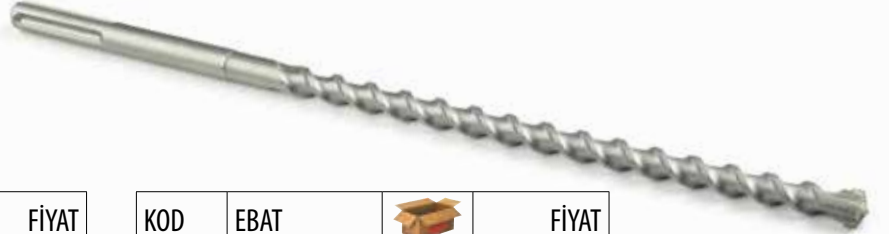
SDS Max Matkap Ucu (4 Elmaslı)



KOD	EBAT		FİYAT
2099	12 x 340 mm	50	5,65 USD
2100	14 x 340 mm	50	5,67 USD
2101	16 x 340 mm	50	6,30 USD
2102	16 x 540 mm	50	9,50 USD
2103	18 x 340 mm	50	6,90 USD
2104	18 x 540 mm	50	9,80 USD
2105	20 x 340 mm	50	7,40 USD
2106	20 x 520 mm	50	10,10 USD
2107	22 x 340 mm	50	8,00 USD
2108	22 x 520 mm	40	11,10 USD
2109	24 x 340 mm	40	11,00 USD
2110	24 x 520 mm	40	14,30 USD
2111	25 x 340 mm	40	11,30 USD
2112	25 x 520 mm	40	14,80 USD
2113	26 x 340 mm	40	13,20 USD
2114	26 x 520 mm	40	17,50 USD
2115	28 x 340 mm	30	14,70 USD
2116	28 x 570 mm	30	20,00 USD

KOD	EBAT		FİYAT
2117	30 x 570 mm	30	21,60 USD
2118	32 x 570 mm	30	28,00 USD
2119	35 x 570 mm	25	30,00 USD
2120	38 x 570 mm	20	37,00 USD
2121	40 x 570 mm	20	47,00 USD
2122	42 x 570 mm	10	55,00 USD
2123	18 x 1000 mm	20	20,00 USD
2124	20 x 1000 mm	20	21,00 USD
2125	22 x 1000 mm	20	23,50 USD
2126	24 x 1000 mm	20	27,00 USD
2127	26 x 1000 mm	20	32,50 USD
2128	28 x 1000 mm	10	38,00 USD
2129	30 x 1000 mm	10	45,00 USD
2130	32 x 1000 mm	10	52,00 USD
2131	35 x 1000 mm	5	61,00 USD
2132	38 x 1000 mm	5	70,00 USD
2133	40 x 1000 mm	5	90,00 USD

Dayanıklı plastik poşetlerdedir.

SDS Ağaç Delme Matkap Ucu



KOD	EBAT		FİYAT
2180	8 x 250 mm	200	1,60 USD
2181	10 x 250 mm	200	1,70 USD
2182	12 x 250 mm	200	1,89 USD
2183	14 x 250 mm	150	2,40 USD
2184	16 x 250 mm	140	2,80 USD
2185	18 x 250 mm	150	3,35 USD
2186	20 x 250 mm	150	3,90 USD
2187	22 x 250 mm	125	4,70 USD
2188	24 x 250 mm	100	5,80 USD



KOD	EBAT		FİYAT
2189	8 x 500 mm	80	2,80 USD
2190	10 x 500 mm	85	2,90 USD
2191	12 x 500 mm	75	3,50 USD
2192	14 x 500 mm	50	4,26 USD
2193	16 x 500 mm	50	5,20 USD
2194	18 x 500 mm	50	6,15 USD
2195	20 x 500 mm	50	7,40 USD
2196	22 x 500 mm	40	8,80 USD
2197	24 x 500 mm	25	10,10 USD

Plastik askılıklardadır.

Yaprak Matkap Ucu Hex Saplı





YENİ

KOD	EBAT			FİYAT
2160	12 mm	50	400	0,99 USD
2161	14 mm	50	400	1,04 USD
2162	16 mm	50	400	1,11 USD
2163	18 mm	50	400	1,16 USD
2164	20 mm	50	400	1,24 USD
2165	22 mm	50	400	1,29 USD
2166	24 mm	50	400	1,34 USD
2167	30 mm	20	240	1,65 USD
2168	35 mm	50	300	1,80 USD
2169	38 mm	20	200	2,10 USD
2170	40 mm	20	240	2,30 USD

Yaprak Matkap Ucu Seti
6 Parçalı

YENİ

KOD	EBAT			FİYAT
2171	12-16-18-20- 22-24 mm	25	100	5,50 USD

SDS Kalıpcı Matkap Ucu



KOD	EBAT		FİYAT
2135	10 x 600 mm	50	3,60 USD
2136	12 x 600 mm	40	4,40 USD
2137	14 x 600 mm	40	5,50 USD
2138	16 x 600 mm	50	5,70 USD

KOD	EBAT		FİYAT
2139	18 x 600 mm	50	6,80 USD
2140	20 x 600 mm	50	7,90 USD
2141	22 x 600 mm	50	8,70 USD
2142	24 x 600 mm	50	10,00 USD

Dayanıklı şeffaf plastik kutulardadır.

SDS Oluklu Keski



KOD	EBAT		FİYAT
2145	14 x 250 mm	100	2.08 USD

Plastik askılıklardadır.

SDS Geniş Keski



KOD	EBAT		FİYAT
2146	14 x 40 x 250 mm	100	2.08 USD

Plastik askılıklardadır.

SDS Plus Keski



KOD	EBAT		FİYAT
2147	14 x 250 mm	100	1.60 USD

Plastik kutulardadır.

SDS Plus Murç



KOD	EBAT		FİYAT
2148	14 x 250 mm	100	1.60 USD

Plastik kutulardadır.

SDS Max Keski



KOD	EBAT		FİYAT
2150	18 x 400 mm	30	4.00 USD
2151	18 x 500 mm	20	4.85 USD
2152	18 x 600 mm	20	5.60 USD

Plastik kutulardadır.

SDS Max Murç



KOD	EBAT		FİYAT
2153	18 x 400 mm	30	4.00 USD
2154	18 x 500 mm	20	4.85 USD
2155	18 x 600 mm	20	5.60 USD

Plastik kutulardadır.

SDS Max Geniş Keski



KOD	EBAT		FİYAT
2160	18 x 50 x 300 mm	25	4.25 USD
2156	18 x 50 x 400 mm	25	4.50 USD

Plastik askılıklardadır.

16 Kg Kırıcılar İçin Keski



KOD	EBAT		FİYAT
2157	26 x 410 x 35 mm	10	12.50 USD

16 Kg Kırıcılar İçin Murç



KOD	EBAT		FİYAT
2158	26 x 410	10	12.50 USD

HSS Havşa Matkap Ucu



KOD	EBAT	MCM		FİYAT
2300	3,0 mm	25	200	2.18 USD
2301	3,5 mm	25	200	2.18 USD
2302	4,0 mm	25	200	2.18 USD

Temizleme Bıçağı



KOD	EBAT	MCM		FİYAT
2315	12x12,7 x 25,4 mm	25	300	3.10 USD

Menteşe Yeri Açma



KOD	ÖZELLİK	MCM		FİYAT
2303	18 mm	30	360	2,00 USD
2304	20 mm	30	360	2,30 USD
2305	22 mm	30	360	2,50 USD
2306	26 mm	30	360	2,80 USD
2307	35 mm	20	240	3,50 USD
2308	40 mm	12	144	3,90 USD
2309	45 mm	12	144	5,00 USD
2310	50 mm	8	96	5,50 USD
2311	54 mm	8	96	6,20 USD
2312	60 mm	6	72	6,60 USD
2313	65 mm	6	72	7,50 USD
2314	70 mm	5	60	8,50 USD

Cam-Seramik Delme Universal Matkap Ucu



KOD	ÖZELLİK		FİYAT
4600	4 mm	20	1,50 USD
4601	5 mm	20	1,50 USD
4602	6 mm	20	1,50 USD
4603	7 mm	20	1,90 USD
4604	8 mm	20	2,00 USD
4605	9 mm	20	2,45 USD
4606	10 mm	20	2,80 USD
4607	12 mm	20	3,40 USD
4608	14 mm	20	4,40 USD

Ahşap Dekupaj Ağzı (5'li paket)



KOD	EBAT	MCM		FİYAT
2240	T 144 - D	100	400	2.05 USD
2241	T 111 - C	100	400	1.37 USD
2242	T 101 - D	100	400	2.77 USD
2243	T344 - D (Uzun)	100	400	2.85 USD

Metal Dekupaj Ağzı (5'li paket)



KOD	EBAT	MCM		FİYAT
2250	T 118 - A	100	400	3.35 USD
2251	T318 - A (Uzun)	100	400	6.25 USD

Ahşap Tilki Kuyruğu (5'li paket)



KOD	EBAT	MCM		FİYAT
2260	S 1531 - L	20	100	8.70 USD

Kemik Kesme Tilki Kuyruğu (5'li paket)



KOD	EBAT	MCM		FİYAT
2282	s1211-K	20	100	10.50 USD



Ytong Tuğla Kesme Tilki Kuyruğu (1'li paket)



KOD	EBAT	MCM		FİYAT
2281	s1243-HM	25	100	15.00 USD
2283	s2243-HM	25	100	22.00 USD



Metal Tilki Kuyruğu (5'li paket)

150 mm

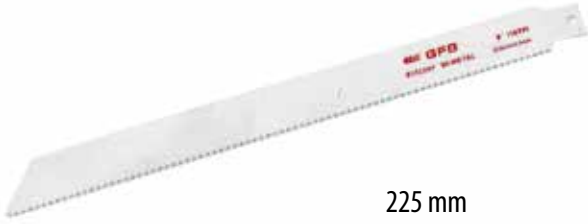
KOD	EBAT			FİYAT
2270	S 922 - EF	20	100	7.90 USD



Metal ve Ahşap Tilki Kuyruğu (5'li paket)

225 mm

KOD	EBAT			FİYAT
2280	S 1122 - HF	20	100	10.50 USD



**Metal Tilki Kuyruğu Uzun (5'li paket)
225 mm**

225 mm

KOD	EBAT			FİYAT
2275	s1122-EF	20	100	12.00 USD

Şerit Metre**YENİ**

İki stoplu mekanizma
Sıfır konumlu siyah kanca
Darbeye dayanıklı ABS kasa
Uzun mesafeli dik durma
EEC II ve MID sertifikalı

KOD	EBAT			FİYAT
5100	3 x 16 mm	12	120	2.20 USD
5101	5 x 19 mm	12	120	3.35 USD
5102	5 x 25 mm	12	96	4.00 USD
5103	10 x 25 mm	12	48	7.60 USD

Alüminyum Freze Ucu (Normal Boy)

KOD	EBAT	MCM	FİYAT
2400	5 x 8 x 80 mm	40	3.30 USD

Alüminyum Freze Ucu (Uzun Boy)

KOD	EBAT	MCM	FİYAT
2401	5 x 8 x 120 mm	10	4.45 USD

Alüminyum Freze Ucu

KOD	EBAT	MCM	FİYAT
2402	5 x 8 x 100 mm	10	4.35 USD

Alüminyum Freze Ucu (Kısa)

KOD	EBAT	MCM	FİYAT
2403	5 x 8 x 60 mm	40	2.75 USD

Alüminyum Freze Ucu (HSS-E Cobalt)

KOD	EBAT	MCM	FİYAT
2404	5 x 8 x 80 mm	40	6.25 USD

Alüminyum Freze Ucu (Arkası İnce)

KOD	EBAT	MCM	FİYAT
2405	5 x 6 x 80 mm	40	2.60 USD

Alüminyum Freze Ucu (Arkası İnce Kısa)**YENİ**

KOD	EBAT	MCM	FİYAT
2406	5 x 6 x 60 mm	40	2.50 USD

Alüminyum Freze Ucu (Arkası İnce Uzun)

KOD	EBAT	MCM	FİYAT
2407	5 x 6 x 100 mm	10	3.85 USD

Alüminyum Freze Ucu (Arkası İnce Uzun)

KOD	EBAT	MCM	FİYAT
2408	5 x 6 x 120 mm	10	4.00 USD

Alüminyum Freze Ucu (Ucu Kalın)

KOD	EBAT	MCM	FİYAT
2409	6 x 8 x 80 mm	40	3.40 USD

Alüminyum Freze Ucu (Arkası Kalın Kısa)**YENİ**

KOD	EBAT	MCM	FİYAT
2410	8 x 8 x 80 mm	10	3.55 USD

Alüminyum Freze Ucu (Arkası Kalın Normal)**YENİ**

KOD	EBAT	MCM	FİYAT
2411	8 x 8 x 100 mm	10	4.35 USD

Alüminyum Freze Ucu (Arkası Kalın Uzun)

KOD	EBAT	MCM	FİYAT
2412	8 x 8 x 120 mm	10	4.50 USD

Alüminyum Freze Ucu (Ucu İnce)

KOD	EBAT	MCM	FİYAT
2413	4 x 8 x 80 mm	40	3.45 USD

Torna Aynaları



Torna Aynası - 3 Ayak

KOD	BOYUTLAR		FİYAT
2598	K 11 - 50/3	1	75,00 USD
2599	K 11 - 63/3	1	88,00 USD
2600	K 11 - 80/3	1	73,00 USD
2601	K 11 - 100/3	1	81,00 USD
2602	K 11 - 125/3	1	92,00 USD
2603	K 11 - 160/3	1	133,00 USD
2604	K 11 - 200/3	1	178,00 USD
2605	K 11 - 250/3	1	245,00 USD
2606	K 11 - 315/3	1	497,00 USD
2607	K 11 - 400/3	1	750,00 USD
2608	K 11 - 500/3	1	1.450,00 USD
2609	K 11 - 600/3	1	4200,00 USD

Karton ve tahta kutudadır



Torna Aynası - 4 Ayak

KOD	BOYUTLAR		FİYAT
2650	K 12 - 100/4	1	110,00 USD
2651	K 12 - 125/4	1	114,00 USD
2652	K 12 - 160/4	1	163,00 USD
2653	K 12 - 200/4	1	220,00 USD
2654	K 12 - 250/4	1	315,00 USD
2655	K 12 - 315/4	1	563,00 USD
2655-1	K 12 - 400/4	1	900,00 USD
2655-2	K 12 - 500/4	1	1600,00 USD
2655-3	K 12 - 630/4	1	4600,00 USD

Karton ve tahta kutudadır

Pens Setleri

**YENİ**

KOD	BOYUTLAR		FİYAT
4985	5 parça / 3-7 mm	1	31,00 USD
4986	8 parça / 3-10 mm	1	36,00 USD
4987	11 parça / 3-13 mm	1	50,00 USD
4988	15 parça / 3-16 mm	1	74,00 USD
4989	18 parça / 3-20 mm	1	94,00 USD
4990	23 parça / 3-26 mm	1	160,00 USD

Plastik kutudadır

Döner Punta



KOD	EBAT	UZUNLUK		FİYAT
2749	1 Mors	115 mm	10	21,00 USD
2750	2 Mors	130 mm	10	27,00 USD
2751	3 Mors	170 mm	10	34,00 USD
2752	4 Mors	210 mm	10	42,00 USD
2753	5 Mors	268 mm	10	58,00 USD

Mors Konik



KOD	EBAT	UZUNLUK		FİYAT
2760	10/2 Mors	101 mm	10	3,25 USD
2761	12/3 Mors	124 mm	10	4,60 USD
2762	16/2 Mors	112 mm	10	3,50 USD
2763	16/3 Mors	131 mm	10	4,10 USD
2764	16/4 Mors	156 mm	10	6,40 USD
2765	18/2 Mors	120 mm	10	3,30 USD
2766	18/3 Mors	139 mm	10	4,00 USD
2767	18/4 Mors	164 mm	10	6,70 USD
2768	22/2 Mors	128 mm	10	6,60 USD
2769	22/3 Mors	147 mm	10	5,20 USD
2770	22/4 Mors	172 mm	10	6,80 USD
2771	24/4 Mors	181 mm	10	8,30 USD

Mors Kovan



KOD	EBAT	UZUNLUK		FİYAT
2780	3 X 2	108 mm	10	4,50 USD
2781	4 X 1	124 mm	10	7,60 USD
2782	4 X 2	124 mm	10	7,60 USD
2783	4 X 3	122 mm	10	7,60 USD
2784	5 X 2	156 mm	10	16,00 USD
2785	5 X 3	156 mm	10	16,00 USD
2786	5 X 4	164 mm	10	16,00 USD

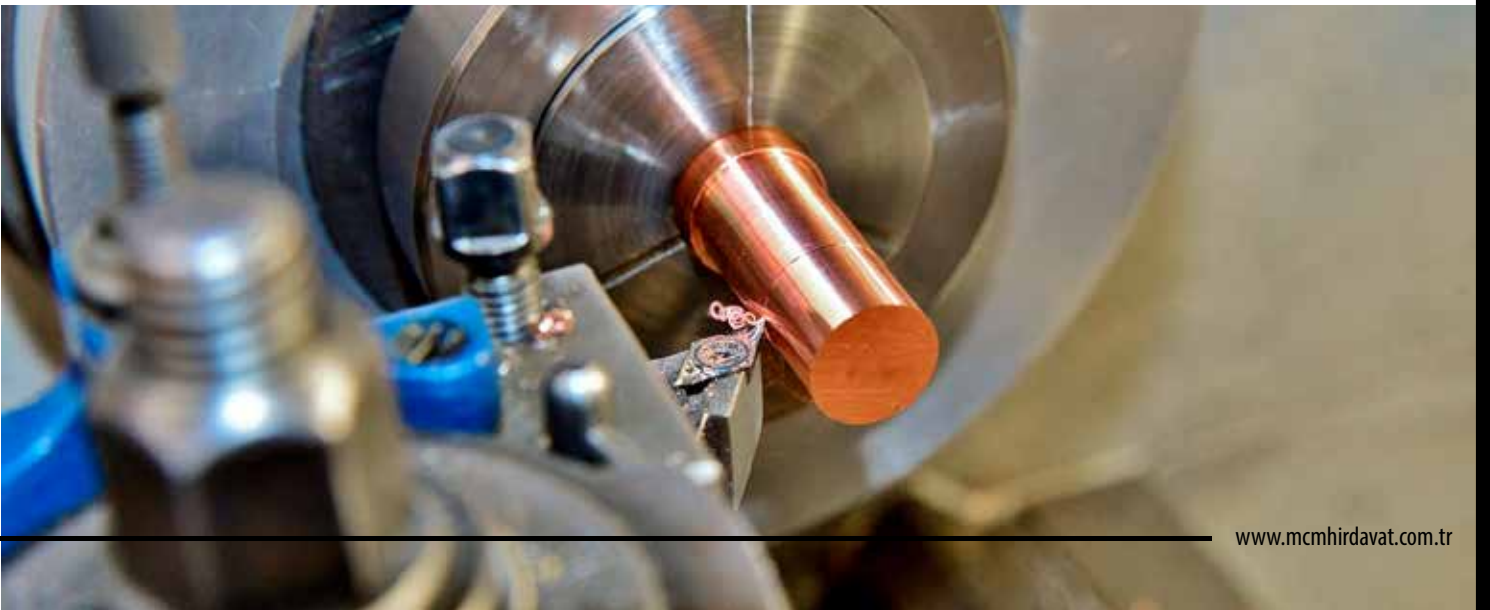

HSS 3'lü Metrik El Takım Kılavuzu - DIN 352



KOD	EBAT	MCM	FİYAT	KOD	EBAT	MCM	FİYAT
3300	M - 3 x 0,5	20	5,90 USD	3308	M - 16 x 2,0	8	18,00 USD
3301	M - 4 x 0,7	20	5,90 USD	3309	M - 18 x 2,5	8	18,70 USD
3302	M - 5 x 0,8	20	6,00 USD	3310	M - 20 x 2,5	8	19,25 USD
3303	M - 6 x 1,0	20	6,20 USD	3311	M - 22 x 2,5	5	27,00 USD
3304	M - 8 x 1,25	20	6,90 USD	3312	M - 24 x 3,0	4	37,50 USD
3305	M - 10 x 1,5	20	7,70 USD	3313	M - 25 x 3,0	4	46,75 USD
3306	M - 12 x 1,75	20	13,00 USD	3314	M - 27 x 3,0	4	59,00 USD
3307	M - 14 x 2,0	8	16,20 USD	3315	M - 30 x 3,5	4	94,00 USD

HSS Titanyum Düz İnce Diş Makina Kılavuzu - DIN 371/376



KOD	EBAT	DIN	FİYAT	KOD	EBAT	DIN	FİYAT
3400	M - 8 x 1,0	371	4,20 USD	3408	M - 14 x 1,5	376	9,30 USD
3401	M - 10 x 1,0	371	5,20 USD	3409	M - 16 x 1,0	376	10,10 USD
3402	M - 10 x 1,25	371	5,20 USD	3410	M - 16 x 1,5	376	10,10 USD
3403	M - 12 x 1,0	376	7,40 USD	3411	M - 18 x 1,0	376	12,45 USD
3404	M - 12 x 1,25	376	7,40 USD	3412	M - 18 x 1,5	376	12,45 USD
3405	M - 12 x 1,5	376	7,40 USD	3413	M - 20 x 1,0	376	17,60 USD
3406	M - 14 x 1,0	376	9,30 USD	3414	M - 20 x 1,5	376	17,60 USD
3407	M - 14 x 1,25	376	9,30 USD	3415	M - 22 x 1,5	376	21,00 USD

HSS Titanyum Düz Makina Kılavuzu - DIN 371/376



KOD	EBAT	DIN	MCM	FİYAT	KOD	EBAT	DIN	MCM	FİYAT
3497	M - 1,6 x 0,35	371	100	7,90 USD	3505-1	M - 11 x 1,5	371	50	7,20 USD
3498	M - 2 x 0,4	371	100	6,85 USD	3506	M - 12 x 1,75	376	20	7,20 USD
3499	M - 2,5 x 0,45	371	100	6,85 USD	3507	M - 14 x 2,0	376	25	9,25 USD
3500	M - 3 x 0,5	371	100	3,10 USD	3508	M - 16 x 2,0	376	20	10,20 USD
3501	M - 4 x 0,7	371	100	3,10 USD	3509	M - 18 x 2,5	376	8	12,45 USD
3502	M - 5 x 0,8	371	50	3,40 USD	3510	M - 20 x 2,5	376	8	18,00 USD
3503	M - 6 x 1,0	371	50	3,40 USD	3511	M - 22 x 2,5	376	8	20,00 USD
3503-1	M - 7 x 1,0	371	50	4,00 USD	3512	M - 24 x 3,0	376	21	30,00 USD
3504	M - 8 x 1,25	371	50	4,10 USD	3513	M - 27 x 3,0	376	18	39,00 USD
3504-1	M - 9 x 1,25	371	50	5,00 USD	3514	M - 30 x 3,5	376	15	49,00 USD
3505	M - 10 x 1,5	371	50	5,00 USD					

HSS Tekli Son Kılavuz - DIN 352



KOD	EBAT	DIN		FİYAT
3580	M - 5 x 0,8	352	100	2,00 USD
3581	M - 6 x 1,0	352	100	2,10 USD
3582	M - 8 x 1,25	352	50	2,25 USD
3583	M - 10 x 1,5	352	50	2,60 USD
3584	M - 12 x 1,75	352	50	4,30 USD

HSS 3'lü El Takım Kılavuzu - DIN 351



KOD	EBAT	UNC	FİYAT
3600	1/8 x 40	UNC	5,95 USD
3601	5/32 x 32	UNC	5,95 USD
3602	3/16 x 24	UNC	5,95 USD
3603	1/4 x 20	UNC	6,40 USD
3604	5/16 x 18	UNC	7,15 USD
3605	3/8 x 16	UNC	8,00 USD
3606	7/16 x 14	UNC	13,75 USD

KOD	EBAT	UNC	FİYAT
3607	1/2 x 12	UNC	13,75 USD
3608	1/2 x 13	UNC	13,75 USD
3609	9/16 x 12	UNC	17,00 USD
3610	5/8 x 11	UNC	18,60 USD
3611	3/4 x 10	UNC	19,60 USD
3612	7/8 x 9	UNC	27,60 USD
3613	1" x 8	UNC	38,00 USD

HSS 3'lü El Takım İnce Diş Kılavuzu - DIN 351





KOD	EBAT	UNF	FİYAT
3650	1/4 x 28	UNF	6,40 USD
3651	5/16 x 24	UNF	7,15 USD
3652	3/8 x 24	UNF	8,15 USD
3653	7/16 x 20	UNF	13,75 USD

KOD	EBAT	UNF	FİYAT
3654	1/2 x 20	UNF	13,75 USD
3655	9/16 x 18	UNF	17,00 USD
3656	5/8 x 18	UNF	18,60 USD
3657	3/4 x 16	UNF	19,60 USD

HSS Titanyum Helis Makina Kılavuzu - DIN 371/C - 376 35 Derece



KOD	EBAT	DIN		FİYAT
3548	M - 2 x 0,4	371	100	8,00 USD
3549	M - 2,5 x 0,45	371	100	6,50 USD
3550	M - 3 x 0,5	371	100	3,30 USD
3551	M - 4 x 0,7	371	100	3,30 USD
3552	M - 5 x 0,8	371	50	3,85 USD
3553	M - 6 x 1,0	371	50	4,40 USD
3554	M - 8 x 1,25	371	50	5,20 USD
3555	M - 10 x 1,5	371	50	5,80 USD

KOD	EBAT	DIN		FİYAT
3556	M - 12 x 1,75	376	20	8,00 USD
3557	M - 13 x 1,0	376	25	9,70 USD
3558	M - 14 x 2,0	376	25	10,50 USD
3559	M - 16 x 2,0	376	20	13,00 USD
3560	M - 18 x 2,5	376	8	15,00 USD
3561	M - 20 x 2,5	376	8	19,50 USD
3562	M - 22 x 2,5	376	16	28,00 USD
3563	M - 24 x 3,0	376	16	35,00 USD
3564	M - 27 x 3,0	376	9	45,00 USD

HSS Titanyum Düz Makina Kılavuzu - DIN 371/376



KOD	EBAT	UNC	FİYAT
3700	1/4 x 20	UNC	3,70 USD
3701	5/16 x 18	UNC	4,30 USD
3702	3/8 x 16	UNC	5,30 USD
3703	7/16 x 14	UNC	7,30 USD
3704	1/2 x 12	UNC	7,50 USD
3705	1/2 x 13	UNC	7,50 USD
3706	9/16 x 12	UNC	9,60 USD
3707	5/8 x 11	UNC	10,45 USD
3708	3/4 x 10	UNC	18,70 USD
3709	7/8 x 9	UNC	22,50 USD
3710	1" x 8	UNC	34,00 USD

HSS Titanyum İnce Diş Düz Makina Kılavuzu - DIN 371/376



KOD	EBAT	UNF	FİYAT	KOD	EBAT	UNF	FİYAT
3750	1/4 x 28	UNF	3,70 USD	3754	1/2 x 20	UNF	7,50 USD
3751	5/16 x 24	UNF	4,30 USD	3755	9/16 x 18	UNF	9,60 USD
3752	3/8 x 24	UNF	5,30 USD	3756	5/8 x 18	UNF	10,45 USD
3753	7/16 x 20	UNF	7,30 USD	3757	3/4 x 16	UNF	18,70 USD

HSS Titanyum Helis Makina Kılavuzu - DIN 371/376 35 Derece



KOD	EBAT	UNC	FİYAT	KOD	EBAT	UNC	FİYAT
3800	1/4 x 20	UNC	4,50 USD	3805	1/2 x 13	UNC	8,30 USD
3801	5/16 x 18	UNC	5,35 USD	3806	9/16 x 12	UNC	10,30 USD
3802	3/8 x 16	UNC	5,90 USD	3807	5/8 x 11	UNC	12,30 USD
3803	7/16 x 14	UNC	7,80 USD	3808	3/4 x 10	UNC	18,15 USD
3804	1/2 x 12	UNC	8,30 USD	3809	7/8 x 9	UNC	25,50 USD
				3810	1" x 8	UNC	38,50 USD

40 Parçalı Kılavuz - Pafta Seti



KOD	ÖZELLİKLER	FİYAT
3960	Kılavuz - pafta seti	43,00 USD

Ters Musluk Kılavuzu

Musluk tesisat kırığı çıkartmak için uygundur.



KOD	ÖZELLİKLER	FİYAT
3970	M 25 - M 35	3,00 USD
3971	M 35 - M 50	4,00 USD

HSS Gaz Diş 2'li El Takım Kılavuzu - DIN 5157



KOD	EBAT	DIN	FİYAT
3850	G 1/8 x 28	5157	9,00 USD
3851	G 1/4 x 19	5157	13,50 USD
3852	G 3/8 x 19	5157	20,50 USD
3853	G 1/2 x 14	5157	29,00 USD

KOD	EBAT	DIN	FİYAT
3854	G 5/8 x 14	5157	42,00 USD
3855	G 3/4 x 14	5157	55,00 USD
3856	G 7/8 x 14	5157	65,00 USD
3857	G 1" x 11	5157	80,00 USD

HSS Gaz Diş Tekli Makina Kılavuzu - DIN 5156



KOD	EBAT	DIN	FİYAT
3900	G 1/8 x 28	5156	4,50 USD
3901	G 1/4 x 19	5156	8,00 USD
3902	G 3/8 x 19	5156	12,00 USD
3903	G 1/2 x 14	5156	17,00 USD
3904	G 5/8 x 14	5156	26,00 USD
3905	G 3/4 x 14	5156	35,00 USD
3906	G 7/8 x 14	5156	48,00 USD
3907	G 1" x 11	5156	55,00 USD

HSS Helikol Kılavuz - DIN 8141



KOD	EBAT	DIN	FİYAT
3770	M - 5 x 0,8	8141	4,30 USD
3771	M - 6 x 1,0	8141	4,30 USD
3772	M - 7 x 1,0	8141	4,30 USD
3773	M - 8 x 1,0	8141	5,80 USD
3774	M - 8 x 1,25	8141	5,80 USD
3775	M - 10 x 1,0	8141	6,50 USD
3776	M - 10 x 1,25	8141	6,50 USD
3777	M - 10 x 1,50	8141	6,50 USD

KOD	EBAT	DIN	FİYAT
3778	M - 12 x 1,25	8141	7,00 USD
3779	M - 12 x 1,50	8141	7,00 USD
3780	M - 12 x 1,75	8141	7,00 USD
3781	M - 14 x 1,25	8141	9,50 USD
3782	M - 14 x 1,50	8141	9,50 USD
3783	M - 16 x 1,50	8141	11,50 USD
3784	M - 18 x 1,50	8141	14,00 USD
3785	M - 20 x 1,50	8141	16,00 USD

Ters Kılavuz Takımı



Ağır hizmet



Hafif hizmet

YENİ

KOD	EBAT	FİYAT
3950	5 parçalı - Hafif hizmet	5,50 USD
3951	6 parçalı - Hafif hizmet	6,30 USD
3955	5 parçalı - Ağır hizmet	6,20 USD
3956	6 parçalı - Ağır hizmet	8,50 USD

HSS Metrik Pafta



KOD	EBAT	FİYAT
4000	M - 3 x 0,5	2,50 USD
4001	M - 4 x 0,7	2,50 USD
4002	M - 5 x 0,8	2,70 USD
4003	M - 6 x 1,0	3,20 USD
4004	M - 8 x 1,25	3,85 USD
4005	M - 10 x 1,5	7,50 USD
4006	M - 12 x 1,75	9,80 USD
4007	M - 14 x 2,0	9,80 USD

KOD	EBAT	FİYAT
4008	M - 16 x 2,0	16,00 USD
4009	M - 18 x 2,5	17,00 USD
4010	M - 20 x 2,5	18,00 USD
4011	M - 22 x 2,5	29,00 USD
4012	M - 24 x 3,0	30,00 USD
4013	M - 27 x 3,0	43,00 USD
4014	M - 30 x 3,5	44,00 USD

HSS Metrik İnce Diş Pafta



KOD	EBAT	FİYAT
4050	M - 8 x 1,0	3,85 USD
4051	M - 10 x 1,0	7,50 USD
4052	M - 10 x 1,25	7,50 USD
4053	M - 12 x 1,25	9,80 USD
4054	M - 12 x 1,50	9,80 USD
4055	M - 14 x 1,25	9,80 USD
4056	M - 14 x 1,50	9,80 USD

KOD	EBAT	FİYAT
4057	M - 16 x 1,50	16,00 USD
4058	M - 18 x 1,25	17,00 USD
4059	M - 18 x 1,50	17,00 USD
4060	M - 20 x 1,50	18,00 USD
4061	M - 20 x 2,0	18,00 USD
4062	M - 22 x 1,50	29,00 USD
4063	M - 22 x 1,25	29,00 USD

HSS Unc Kalın Diş Pafta



KOD	EBAT	FİYAT
4100	1/4 x 20	3,40 USD
4101	5/16 x 18	3,85 USD
4102	3/8 x 16	7,70 USD
4103	7/16 x 14	9,90 USD
4104	1/2 x 12	9,90 USD

KOD	EBAT	FİYAT
4105	1/2 x 13	9,90 USD
4106	9/16 x 12	13,20 USD
4107	5/8 x 11	17,05 USD
4108	3/4 x 10	17,60 USD
4109	7/8 x 9	31,00 USD
4110	1" x 8	32,00 USD

HSS Gaz Diş Pafta - DIN 5158



KOD	EBAT	FİYAT
4130	G 1/8 x 28	10,00 USD
4131	G 1/4 x 19	13,00 USD
4132	G 3/8 x 19	21,00 USD
4133	G 1/2 x 14	26,60 USD

KOD	EBAT	FİYAT
4134	G 5/8 x 14	36,00 USD
4135	G 3/4 x 14	39,00 USD
4136	G 7/8 x 14	65,00 USD
4137	G 1" x 11	69,00 USD

Cırcırlı Kılavuz Kolu (Kısa)



KOD	EBAT		FİYAT
4150	No 1 M 3 - M 8	10	8,40 USD
4151	No 2 M 5 - M 12	10	11,80 USD

Plastik blister ambalajlıdır.

Cırcırlı Kılavuz Kolu (Uzun)



KOD	EBAT		FİYAT
4200	No 1 M 3 - M 8	8	12,30 USD
4201	No 2 M 5 - M 12	8	15,30 USD

Plastik blister ambalajlıdır.

Kılavuz Kolu



KOD	EBAT		FİYAT
4250	NO 1 M 3 - M 10	50	6,70 USD
4251	NO 2 M 4 - M 12	40	9,20 USD
4252	NO 3 M 5 - M 20	30	15,20 USD
4253	NO 4 M 9 - M 27	20	21,50 USD

Plastik blister ambalajlıdır.

Pafta Kolu



KOD	EBAT		FİYAT
4300	NO 20 M 4 - M 6	50	4,90 USD
4301	NO 25 M 7 - M 9	40	6,30 USD
4302	NO 30 M 10 - M 11	40	8,00 USD
4303	NO 38 M 12 - M 14	20	9,30 USD
4304	NO 45 M 16 - M 20	15	13,50 USD
4305	NO 55 M 22 - M 24	10	21,50 USD

Plastik blister ambalajlıdır.

HSS 4 Ağızlı Standart Freze



KOD	EBAT	KESME	TAM BOY	ŞAFT	FİYAT
2800	3,0 mm	8	52	6	3,25 USD
2801	4,0 mm	11	52	6	3,25 USD
2802	5,0 mm	13	57	6	3,45 USD
2803	6,0 mm	13	57	6	3,45 USD
2804	7,0 mm	16	66	10	5,20 USD
2805	8,0 mm	19	69	10	5,20 USD
2806	9,0 mm	19	69	10	6,60 USD
2807	10,0 mm	22	72	10	6,70 USD
2808	11,0 mm	22	79	12	8,60 USD
2809	12,0 mm	26	83	12	9,10 USD
2810	13,0 mm	26	83	12	10,10 USD
2811	14,0 mm	26	83	12	10,90 USD
2812	15,0 mm	26	83	12	12,00 USD

KOD	EBAT	KESME	TAM BOY	ŞAFT	FİYAT
2813	16,0mm	32	92	16	12,30 USD
2814	17,0mm	32	92	16	13,60 USD
2815	18,0mm	32	92	16	14,40 USD
2816	19,0mm	32	92	16	19,35 USD
2817	20,0mm	38	104	20	19,50 USD
2817-1	21,0mm	38	104	20	23,00 USD
2818	22,0mm	38	104	20	23,00 USD
2818-1	23,0mm	38	104	20	30,00 USD
2819	24,0mm	45	121	25	30,70 USD
2820	25,0mm	45	121	25	31,00 USD
2821	26,0mm	45	121	25	38,00 USD
2821-1	27,0mm	45	121	25	41,00 USD
2822	28,0mm	45	121	25	42,00 USD
2822-1	29,0mm	45	121	25	44,00 USD
2823	30,0mm	45	121	25	45,80 USD
2824	32,0mm	53	133	32	53,30 USD
2825	35,0mm	53	133	32	80,00 USD
2826	36,0mm	53	133	32	80,00 USD
2827	38,0mm	63	155	32	86,00 USD
2828	40,0mm	63	155	40	125,00 USD

HSS 4 Ağızlı Uzun Freze



KOD	EBAT	KESME	TAM BOY	ŞAFT	FİYAT
2850	3,0 mm	12	56	6	4,10 USD
2851	4,0 mm	19	63	6	4,10 USD
2852	5,0 mm	24	68	6	4,50 USD
2853	6,0 mm	24	68	6	4,50 USD
2854	8,0 mm	38	88	10	7,65 USD
2855	10,0 mm	45	95	10	8,00 USD
2856	12,0 mm	53	110	12	12,35 USD
2857	14,0 mm	53	110	12	14,70 USD
2858	16,0 mm	63	123	16	18,00 USD

Dayanıklı plastik kutulardadır.

KOD	EBAT	KESME	TAM BOY	ŞAFT	FİYAT
2859	18,0 mm	63	123	16	20,70 USD
2860	20,0 mm	75	141	20	27,75 USD
2861	22,0 mm	75	141	20	32,25 USD
2862	24,0 mm	90	166	25	44,10 USD
2863	25,0 mm	90	166	25	44,70 USD
2864	28,0 mm	90	166	25	63,60 USD
2865	30,0 mm	90	166	25	64,00 USD
2866	32,0 mm	106	186	32	70,80 USD

Dayanıklı plastik kutulardadır.

HSS 4 Ağızlı Titan Kaplı Freze



KOD	EBAT	KESME	TAM BOY	ŞAFT	FİYAT
2900	3,0 mm	8	52	6	4,30 USD
2901	4,0 mm	11	52	6	4,30 USD
2902	5,0 mm	13	57	6	4,60 USD
2903	6,0 mm	13	57	6	4,60 USD
2904	8,0 mm	19	69	10	6,20 USD
2905	10,0 mm	22	72	10	8,00 USD
2906	12,0 mm	26	83	12	11,00 USD
2907	14,0 mm	26	83	12	13,20 USD
2908	16,0 mm	32	92	16	15,20 USD

KOD	EBAT	KESME	TAM BOY	ŞAFT	FİYAT
2909	18,0 mm	32	92	16	17,40 USD
2910	20,0 mm	38	104	20	22,50 USD
2911	22,0 mm	38	104	20	27,00 USD
2912	24,0 mm	45	121	25	35,00 USD
2913	25,0 mm	45	121	25	35,00 USD
2914	28,0 mm	45	121	25	46,00 USD
2915	30,0 mm	45	121	25	50,00 USD
2916	32,0 mm	53	133	32	54,00 USD

Dayanıklı plastik kutulardadır.

HSS 4 Ağızlı Kabatalaş Freze



KOD	EBAT	KESME	TAM BOY	ŞAFT	FİYAT
2950	6,0 mm	13	57	6	9,50 USD
2951	7,0 mm	16	66	10	10,00 USD
2952	8,0 mm	19	69	8	10,30 USD
2953	10,0 mm	22	72	10	11,50 USD
2954	12,0 mm	26	83	12	13,50 USD
2955	14,0 mm	26	83	12	16,70 USD
2956	16,0 mm	32	92	16	18,50 USD
2957	18,0 mm	32	92	16	22,00 USD

KOD	EBAT	KESME	TAM BOY	ŞAFT	FİYAT
2958	20,0 mm	38	104	20	25,50 USD
2959	22,0 mm	38	104	20	37,30 USD
2960	25,0 mm	45	121	25	45,00 USD
2961	28,0 mm	45	121	25	58,00 USD
2962	30,0 mm	45	121	25	67,00 USD
2963	32,0 mm	53	133	32	75,00 USD
2964	34,0 mm	53	133	32	85,00 USD
2965	35,0 mm	53	133	32	88,00 USD

Dayanıklı plastik kutulardadır.

HSS Havşa Freze 90 Derece



KOD	EBAT	FİYAT
3174	8,3 mm	4,60 USD
3175	10,4 mm	5,40 USD
3176	12,4 mm	5,90 USD
3177	16,0 mm	6,80 USD
3178	16,5 mm	6,80 USD
3179	20,0 mm	8,60 USD
3180	20,5 mm	8,90 USD

KOD	EBAT	FİYAT
3181	25,0 mm	12,40 USD
3182	25,5 mm	12,40 USD
3183	30,0 mm	18,35 USD
3184	31,5 mm	19,35 USD
3185	35,0 mm	27,00 USD
3186	40,0 mm	31,00 USD
3187	50,0 mm	47,00 USD

HSS 2 Ağızlı Freze



KOD	EBAT	KESME	TAM BOY	ŞAFT	FİYAT
3000	3,0 mm	7	51	6	3,30 USD
3001	4,0 mm	7	51	6	3,30 USD
3002	5,0 mm	8	52	6	3,45 USD
3003	6,0 mm	8	52	6	3,45 USD
3004	8,0 mm	11	61	10	4,85 USD
3005	10,0 mm	13	63	10	6,60 USD

KOD	EBAT	KESME	TAM BOY	ŞAFT	FİYAT
3006	12,0 mm	16	73	12	8,50 USD
3007	14,0 mm	16	73	12	10,20 USD
3008	16,0 mm	19	79	16	11,70 USD
3009	18,0 mm	19	79	16	13,50 USD
3010	20,0 mm	22	88	20	17,50 USD
3011	22,0 mm	22	88	20	21,50 USD

4 Ağızlı Karbür Freze



KOD	EBAT	KESME	TAM BOY	ŞAFT	FİYAT
3050	1,0 mm	10	50	4	3,70 USD
3051	1,5 mm	10	50	4	3,70 USD
3052	2,0 mm	10	50	4	3,70 USD
3053	2,5 mm	10	50	4	3,70 USD
3054	3,0 mm	10	50	3	3,70 USD
3055	4,0 mm	12	50	4	3,70 USD
3056	5,0 mm	15	50	5	6,80 USD
3057	6,0 mm	15	57	6	7,80 USD
3058	7,0 mm	20	60	8	12,00 USD
3059	8,0 mm	20	63	8	12,50 USD

KOD	EBAT	KESME	TAM BOY	ŞAFT	FİYAT
3060	9,0 mm	25	67	10	19,00 USD
3061	10,0 mm	25	75	10	19,00 USD
3062	11,0 mm	25	75	11	25,00 USD
3063	12,0 mm	25	75	12	26,00 USD
3064	13,0 mm	25	83	14	46,00 USD
3065	14,0 mm	40	100	14	48,00 USD
3066	16,0 mm	45	100	16	59,00 USD
3067	18,0 mm	50	100	18	70,00 USD
3068	20,0 mm	50	100	20	95,00 USD

4 Ağızlı Karbür Küresel Elmas Freze



KOD	EBAT	KESME	TAM BOY	ŞAFT	FİYAT
3080	3,0 mm	10	50	3	6,00 USD
3081	4,0 mm	12	50	4	6,00 USD
3082	5,0 mm	15	50	5	10,00 USD
3083	6,0 mm	15	50	6	10,00 USD
3084	8,0 mm	20	60	8	17,00 USD
3085	10,0 mm	25	70	10	24,00 USD
3086	12,0 mm	25	70	12	32,00 USD
3087	14,0 mm	30	80	14	63,00 USD
3088	16,0 mm	35	90	16	75,00 USD

HSS Torna Kalemi - 4 Köşeli



KOD	EBAT	MCM	FİYAT
3100	6 x 6 x 200 mm	40	1,80 USD
3101	8 x 8 x 150 mm	20	2,35 USD
3102	8 x 8 x 200 mm	20	3,00 USD
3103	10 x 10 x 150 mm	15	3,50 USD
3104	10 x 10 x 200 mm	15	4,60 USD
3105	12 x 12 x 150 mm	10	5,00 USD
3106	12 x 12 x 200 mm	10	6,00 USD
3107	14 x 14 x 200 mm	8	8,00 USD
3108	16 x 16 x 200 mm	6	10,50 USD
3109	18 x 18 x 200 mm	3	13,50 USD
3110	20 x 20 x 200 mm	3	17,00 USD

HSS Patograf Kalemi (Yuvarlak)



KOD	EBAT	MCM	FİYAT
3170	6 x 160 mm	40	1,40 USD
3171	8 x 160 mm	20	2,30 USD
3172	10 x 160 mm	15	3,60 USD
3173	12 x 160 mm	10	5,10 USD

HSS Trapez Keski Kalemi (Zavyeli)



KOD	EBAT	MCM	FİYAT
3160	1/2 - 3 x 4 x 160 mm	36	4,00 USD
3161	5/8 - 3 x 4 x 160 mm	30	5,00 USD
3162	3/4 - 3 x 4 x 160 mm	25	6,00 USD
3163	7/8 - 3 x 4 x 160 mm	20	7,00 USD

HSS Punta Ucu



KOD	EBAT	MCM	FİYAT
3198	1,6 mm	10	1,20 USD
3199	2,0 mm	10	1,30 USD
3200	2,5 mm	10	1,60 USD
3201	3,15 mm	10	1,85 USD
3202	4,0 mm	10	2,55 USD
3203	5,0 mm	5	4,55 USD
3204	6,3 mm	5	8,00 USD
3205	8,0 mm	1	16,00 USD
3206	10,0 mm	1	23,00 USD

HSS Torna Keski Kalemi - Yassı



KOD	EBAT	MCM	FİYAT
3150	1/2 - 4 x 160 mm	30	2,30 USD
3151	5/8 - 4 x 160 mm	25	2,90 USD
3152	3/4 - 4 x 160 mm	20	3,30 USD
3153	7/8 - 4 x 160 mm	20	4,10 USD

HSS Punta Ucu Uzun



YENİ

KOD	EBAT	MCM	FİYAT
3192	2,00 mm	1	3,00 USD
3193	2,50 mm	1	3,20 USD
3194	3,15 mm	1	4,30 USD
3195	4,00 mm	1	6,20 USD
3196	5,00 mm	1	9,50 USD
3197	6,30 mm	1	15,50 USD

HSS Punta Çürütme



YENİ

KOD	EBAT	MCM	FİYAT
3188	6,0 x 66 mm	10	2,50 USD
3189	7,0 x 74 mm	10	2,90 USD
3190	8,0 x 79 mm	10	4,00 USD
3191	10,0 x 79 mm	10	6,00 USD

A - Silindir Düz



KOD	EBAT	ÇAP	KESME BOYU	BOY	ARKA ŞAFT	FİYAT
3210	A06 X16 X 06	6	16	65	6	4,00 USD
3211	A08 X 20 X 06	8	20	65	6	5,30 USD
3212	A10 X 20 X 06	10	20	65	6	6,60 USD
3213	A12 X 25 X 06	12	25	65	6	10,00 USD
3214	A16 X 25 X 06	16	25	65	6	17,50 USD

B - Silindir Alın Kesmeli



KOD	EBAT	ÇAP	KESME BOYU	BOY	ARKA ŞAFT	FİYAT
3215	B06 X16 X 06	6	16	65	6	4,00 USD
3216	B08 X 20 X 06	8	20	65	6	5,30 USD
3217	B10 X 20 X 06	10	20	65	6	6,60 USD
3218	B12 X 25 X 06	12	25	65	6	10,00 USD
3219	B16 X 25 X 06	16	25	65	6	17,50 USD

C - Silindir Oval Başlı



KOD	EBAT	ÇAP	KESME BOYU	BOY	ARKA ŞAFT	FİYAT
3220	C06 X16 X 06	6	16	65	6	4,00 USD
3221	C08 X 20 X 06	8	20	65	6	5,30 USD
3222	C10 X 20 X 06	10	20	65	6	6,60 USD
3223	C12 X 25 X 06	12	25	65	6	10,00 USD
3224	C16 X 25 X 06	16	25	65	6	17,50 USD

D - Silindir Küre Başlı



KOD	EBAT	ÇAP	KESME BOYU	BOY	ARKA ŞAFT	FİYAT
3225	D06 X 05 X 06	6	5	65	6	3,65 USD
3226	D08 X 07 X 06	8	7	65	6	5,00 USD
3227	D10 X 09 X 06	10	9	65	6	6,20 USD
3228	D12 X 10 X 06	12	10	65	6	9,00 USD
3229	D16 X 14 X 06	16	14	65	6	16,00 USD

E - Oval Gövdeli



KOD	EBAT	ÇAP	KESME BOYU	BOY	ARKA ŞAFT	FİYAT
3230	E06 X10 X 06	6	10	65	6	3,65 USD
3231	E08 X 13 X 06	8	13	65	6	5,00 USD
3232	E10 X 16 X 06	10	16	65	6	6,20 USD
3233	E12 X 20 X 06	12	20	65	6	9,00 USD
3234	E16 X 25 X 06	16	25	65	6	16,00 USD

F - Küre Uçlu Çam



KOD	EBAT	ÇAP	KESME BOYU	BOY	ARKA ŞAFT	FİYAT
3235	F06 X18 X 06	6	18	65	6	3,65 USD
3236	F08 X 20 X 06	8	20	65	6	5,00 USD
3237	F10 X 20 X 06	10	20	65	6	6,20 USD
3238	F12 X 25 X 06	12	25	65	6	8,30 USD
3239	F16 X 25 X 06	16	25	65	6	16,00 USD

G - Sivri Çam



KOD	EBAT	ÇAP	KESME BOYU	BOY	ARKA ŞAFT	FİYAT
3240	G06 X18 X 06	6	18	65	6	3,65 USD
3241	G08 X 20 X 06	8	20	65	6	5,00 USD
3242	G10 X 20 X 06	10	20	65	6	6,20 USD
3243	G12 X 25 X 06	12	25	65	6	9,00 USD
3244	G16 X 25 X 06	16	25	65	6	16,00 USD

H - Alev



KOD	EBAT	ÇAP	KESME BOYU	BOY	ARKA ŞAFT	FİYAT
3245	H06 X18 X 06	6	18	65	6	4,00 USD
3246	H08 X 20 X 06	8	20	65	6	5,30 USD
3247	H10 X 25 X 06	10	25	65	6	6,60 USD
3248	H12 X 32 X 06	12	32	65	6	10,00 USD
3249	H16 X 36 X 06	16	36	65	6	17,50 USD

L - Konik Yuvarlak



KOD	EBAT	ÇAP	KESME BOYU	BOY	ARKA ŞAFT	FİYAT
3250	L06 X16 X 06	6	16	65	6	3,65 USD
3251	L08 X 22 X 06	8	22	65	6	5,00 USD
3252	L10 X 25 X 06	10	25	65	6	6,20 USD
3253	L12 X 28 X 06	12	28	65	6	9,00 USD
3254	L16 X 33 X 06	16	33	65	6	16,00 USD

M - Konik Sivri



KOD	EBAT	ÇAP	KESME BOYU	BOY	ARKA ŞAFT	FİYAT
3255	M06 X18 X 06	6	18	65	6	3,65 USD
3256	M08 X 20 X 06	8	20	65	6	5,00 USD
3257	M10 X 20 X 06	10	20	65	6	6,20 USD
3258	M12 X 25 X 06	12	25	65	6	9,00 USD
3259	M16 X 25 X 06	16	25	65	6	16,00 USD

Kauçuk Kaynak Hortumu

Kauçuk Kaynak Hortumu,
20 Bar Çalışma Basıncı,
60 Bar Patlama Basıncı

8 X 15
20 BAR
ISO 3821

1 TOP (100 M)

1 METRE: **0.70 USD**



ECO/CONTINENTAL

Kauçuk Kaynak Hortumu

ISO 3821
EN 559

8 X 16
1 TOP (100 M)

1 METRE: **1.00 USD**



MASTER
by CONTINENTAL

Kauçuk Kaynak Hortumu Çiftli

8 X 16
1 TOP (100 M)

1 METRE: **2.15 USD**



MASTER Twin

Polietilen Spiral Hortum

Polietilen Hava Hortumu
Sarı, mavi, kırmızı ve turuncu

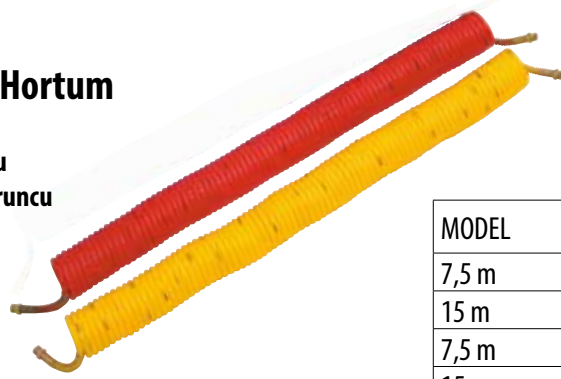

MODEL	BOYUTLAR		FİYAT
7,5 m	5 x 8 mm	50	4.75 USD
15 m	5 x 8 mm	25	7.25 USD
7,5 m	8 x 12 mm	50	10.00 USD
15 m	8 x 12 mm	25	15.50 USD

Poliüretan Spiral Hortum



MODEL	BOYUTLAR		FİYAT
7,5 m	8 x 12 mm	50	20.00 USD
15 m	8 x 12 mm	25	34.00 USD

Spiral Hortum Seti

Polietilen 5 X 8 mm 5 Metre Şeffaf
Kısa hava tabancalı



12.00 USD

 30

Spiral Hortum Seti

Polietilen 5 X 8 mm 5 Metre Şeffaf
Uzun hava tabancalı



13.50 USD

 30

Plastik Saplı Spiralli Hortum Setleri



Polietilen 5x8 5 metre
kısa hava tabancalı

MODEL		FİYAT
Kısa hava tabancalı	50	6.00 USD
Uzun hava tabancalı	25	6.75 USD



Polietilen 5x8 5 metre
uzun hava tabancalı

Plastik Saplı Tabancalar



Kısa hava tabancası

MODEL		FİYAT
Kısa hava tabancası	50	3.00 USD
Uzun hava tabancası	25	3.50 USD



Uzun hava tabancası

1/2 Erkek, 1/4 Dişi Kaplin Gövde (Otomat)



3.75 USD



Hortum Uçlu Kaplin Gövde (Otomat)



BOYUT	MCM		FİYAT
8 mm	50	300	3.75 USD
10 mm	50	300	3.75 USD

Dişi Yedek Uç 1/4" (Otomat)



0.90 USD



Erkek Yedek Uç 1/4" (Otomat)



0.90 USD



Kaynakçı Pano Tipi Gövde



ÖLÇÜ	MCM		FİYAT
6 mm	25	300	4.90 USD
8 mm	25	300	4.90 USD

Redüksiyon (Sarı)



Sarı Erkek Hortum Rekoru



ÖLÇÜ	MCM		FİYAT
1/8" x 6 mm	25	500	0.90 USD
1/8" x 8 mm	25	500	0.90 USD
1/8" x 10 mm	25	500	0.90 USD
1/8" x 13 mm	25	500	0.95 USD
1/4" x 6 mm	25	500	1.10 USD
1/4" x 8 mm	25	500	1.10 USD
1/4" x 10 mm	25	500	1.10 USD
1/4" x 13 mm	25	500	1.10 USD
3/8" x 6 mm	25	400	1.25 USD
3/8" x 8 mm	25	400	1.25 USD
3/8" x 10 mm	25	400	1.25 USD
3/8" x 13 mm	25	400	1.35 USD
3/8" x 16 mm	25	400	1.35 USD
1/2" x 6 mm	25	300	1.35 USD
1/2" x 8 mm	25	300	1.35 USD
1/2" x 10 mm	25	300	1.35 USD
1/2" x 13 mm	25	300	1.35 USD
1/2" x 16 mm	25	300	1.55 USD

BOYUT	MCM		FİYAT
1/4 - 1/8"	25	500	0.60 USD
3/8 - 1/8"	25	500	0.75 USD
3/8 - 1/4"	25	500	0.75 USD
1/2 - 1/8"	25	500	1.10 USD
1/2 - 1/4"	25	500	1.10 USD
1/2 - 3/8"	25	500	1.10 USD
3/4 - 1/4"	25	500	1.75 USD
3/4 - 1/8"	25	500	1.90 USD
3/4 - 3/8"	25	400	1.60 USD
3/4 - 1/2"	25	400	1.35 USD
1 - 3/8"	25	400	2.50 USD
1 - 1/2"	25	400	2.50 USD

Manşon (Sarı)



BOYUT	MCM		FİYAT
1/8"	50	500	0.70 USD
1/4"	50	500	0.90 USD
3/8"	50	500	1.20 USD
1/2"	30	300	1.70 USD
3/4"	25	250	2.25 USD



Hortum Eki (Sarı)



BOYUT			FİYAT
8 mm	50	500	1.05 USD
10 mm	50	500	1.35 USD



Yuvarlak Yedek Uç (Otomat)



BOYUT			FİYAT
6 mm	50	1250	0.85 USD
8 mm	50	1250	0.85 USD
10 mm	50	1250	0.85 USD



Hortum T (Sarı)

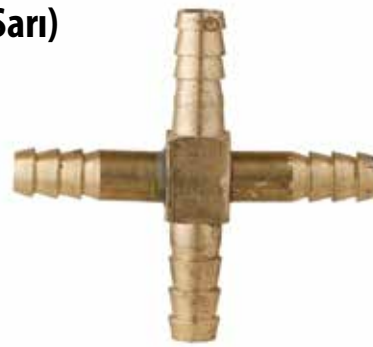

BOYUT			FİYAT
6 mm	50	500	1.65 USD
8 mm	50	500	2.40 USD
10 mm	50	500	2.70 USD
13 mm	50	500	3.50 USD

4'lü Hortum Ekleme (Sarı)



BOYUT			FİYAT
6 mm	50	500	2.85 USD
8 mm	50	500	4.05 USD
10 mm	50	500	5.80 USD
13 mm	50	300	8.50 USD

1/2 Parmak 2'li Hava Dağıtıcı



3.50 USD

 10
 100

1/2 Parmak 3'lü Hava Dağıtıcı





5.50 USD

 10
 100

Mini Küresel Vana Plastik Saplı



ÖLÇÜ			FİYAT
1/8"	25	250	4.00 USD
1/4"	25	250	4.00 USD
3/8"	25	250	4.00 USD
1/2"	25	250	4.50 USD

Mini Kaynak Seti

Kaynak makinesi
Makas
20-25-32 mm pafta
Allen anahtar
Sehpa
Çanta



YENİ

40.00 USD

1500 W Boru Kaynak Seti

Kaynak makinesi
Makas
20-25-32-40 mm pafta
Allen anahtar
Topuzlu saplama
Sehpa
Metre
Terazi
Çanta



YENİ

60.00 USD

Kaynak Paftaları



ÜRÜN	FİYAT
20 mm pafta	3.00 USD
25 mm pafta	3.50 USD
32 mm pafta	5.00 USD
40 mm pafta	6.50 USD
50 mm pafta	9.00 USD
63 mm pafta	11.50 USD
75 mm pafta	14.50 USD
90 mm pafta	20.00 USD
110 mm pafta	25.50 USD
125 mm pafta	32.00 USD
160 mm pafta	63.00 USD

YENİ

Test Pompası 60 Bar



YENİ

130.00 USD

Folyolu Boru Traş Aparatları



ÜRÜN	FİYAT
20 - 25 mm kalemtraş	11.00 USD
32 - 40 mm kalemtraş	13.00 USD
50 - 63 mm kalemtraş	20.70 USD
75 mm kalemtraş	21.70 USD
75 - 90 mm kalemtraş	30.85 USD
110 mm kalemtraş	37.00 USD

YENİ

**Alttan Depolu
Boya Tabancası
G 70**



21.00 EURO



**Üstten Depolu
Boya Tabancası
E 70**



20.00 EURO



**Gölge Tabancası
C & CV**



27.00 EURO



**Lastik Şişirme Tabancası
Alüminyum Gövde**



10.50 EURO



**Küçük Köpük Tabancası
501 E Alüminyum Gövde**

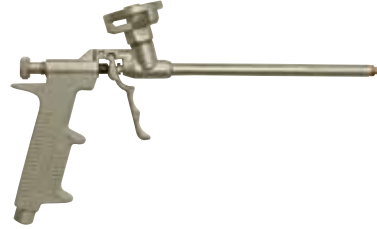

12.00 EURO



**Kısa Hava Tabancası
Alüminyum Gövde**



4.40 EURO



**Uzun Hava Tabancası
Alüminyum Gövde**



5.40 EURO



**Mazot Tabancası
Alüminyum Gövde**



11.00 EURO



ROX Kısa Hava Tabancası



3.60 EURO



YENİ

Dayanıklı plastik gövde.
Ergonomik tasarım.
Ürün üzerindeki çevirmeli anahtar sayesinde,
tetige basıldığında namludan çıkan hava
akışını ayarlama imkanı.

ROX Uzun Hava Tabancası



3.80 EURO



5 Çekmeceli Takım Dolabı Master Pro K7199301

Boyutlar: 59,85 X 37,76 X 59,85
Taşıma kapasitesi: 50 Kg
Ayrılabilir gövde
Alüminyum tutma kulpları

214.50 USD

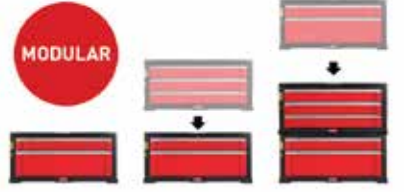

Teleskobik Takım Çantası Master Pro K17181008

Boyutlar: 64,5 X 37,3 X 44,9
Teleskobik metal tutamak
Güçlü çelik kilitler
Geniş ve kuvvetli tasarım
Kaydırmaz taban

139.00 USD



Konsol Tip Takım Çantası Master Pro K17187311

Boyutlar: 56,7 X 31,4 X 24,5
Profesyonel kullanıma uygun
Arka destek ayakları ile dengeli kullanım
Metal kilitler
Yumuşak tutamak
Şeffaf kapak

79.00 USD



Teknisyen Çantası

Boyutlar: 48x38x17,8
Ağır Himete uygun,
Metal kulplu,
4 bölmeli, 1'i çıkarılabilir kutulu

86.00 USD



Connect Cantilever Organizer 17203103

Boyutlar: 56.5 x 31.7 x 16.1 cm
Bölünebilir gövde yapısı
Metal kilitler
Koli adedi: 4

71.50 USD



Sürgülü Kapaklı Takım Sandığı Master Pro K7191709

Boyutlar: 61,6 X 37,8 X 59,85
Merkezi otomatik kilitli sürgülü kapak
Ayrılabilir alet kapları
Patentli sürgülü tasarım

125.00 USD



Tekerlekli Takım Çantası Master Pro K17182387

25" + 22"
Boyutlar: 64,5 X 37,3 X 63,5
Tekerlekli 25" + Portatif 22" takım çantası
Teleskobik taşıma kolu
Metal kilitli
Kauçuk kaydırmaz tabanlıklar

186.00 USD



RIGID SYSTEM

Rigid Bond Tipi

Boyutlar: 56,4 L X 35,0 W X 16,5 H cm
Kapasite: 14,5 Lt

83.00 USD



Profesyonel kullanım
amacı ile tasarlanmış
güçlü dayanıklı gövde.

Suya dayanıklı, su
geçirmez özellikli.

3 parça veya set olarak
kullanma imkanı.



Rigid Portatif

Boyutlar: 56,4 L X 35,0 W X 31,0 H cm
Kapasite: 36,0 Lt

93.50 USD



Rigid Tekerlekli

Boyutlar: 56,4 L X 35,0 W X 48,0 H cm
Kapasite: 56,0 Lt

179.00 USD



= ~~355.50 USD~~

322.00 USD

Mastermate Usta Dostu
Takım Sandığı
Pro K17330826

117.00 USD



Boyutlar: 69 X 35,5 X 40
Metal tutma kulpu
Kauçuk kavrama
Hareketli, çıkarılabilir bölümler



Otomatik Kilitli Takım Çantası Master Pro K17185156

Boyutlar: 66 X 28,7 X 26,3 cm
Merkezi otomatik kilitli sürgülü kapak
Ayrılabilir alet kapları
Patentli sürgülü tasarım



79.00 USD



SMART ROLLING SYSTEM 17203038

Boyutlar: 56.4 x 37.3 x 70 cm
Kapasite: 88.4 L



180.00 USD



Cantilever Job Box 17203037

Boyutlar: 64.6 x 37.3 x 41 cm
Bölünebilir gövde yapısı
Metal kilitler



122.00 USD



Easy Go Breeze Çok Amaçlı Taşıma Kovası

Boyutlar: 51 x 56 x 84 cm
Kapasite: 50 Lt



42.50 USD



Hammer Mastercar 2 Katlı Takım Sandığı

Büyük kapasiteli, dayanıklı ve pratik bir mobil alet kutusu.
Çeşitli boyutlardaki aletlerin depolanması için geniş modüler tasarım.
Boyutlar: 11,42 X 16,54 X 24,61 cm

105.00 USD



Rox ULV Mini Dezenfektan Makinesi

150.00 USD



YENİ



Dezenfektan pulvarizasyonunda ulaşılan yüksek teknoloji sayesinde
9 mikron partikül boyuna sahiptir
ve patenti alınarak tescil edilmiş CE belgeli bir üründür

Brand & Model / Marka ve Model :	ROX - ULV Mini
Input Power / Giriş Gücü :	220-240V -- AC 50/60 Hz
Power / Nominal Güç :	550 Watt (turbine motor)
Disinfectant Capacity / İlaçlama Kapasitesi :	0,85 ml per min / dakikadaki ilaçlama kapasitesi
Tank Capacity / Tank Hacmi :	1.7 Lt
Atomization Particles Size / Atomizasyon Partikül Boyu :	9 Micron
Carton Quantity / Koli Adeti :	6 pcs / adet
Palet Quantity / Palet Adeti :	96 pcs / adet

C&B Oxi Granül Dezenfektan Biyosidal Ruhsatlı 5 Gr toz ambalaj (5 Litre sıvı)

Başlıca Kullanım Alanları

- El dezenfektanı
- İçme suyu dezenfektanı
- Su arıtımı için dezenfektan ve saflaştırma kimyasalı
- Suda yosun oluşmasını önleyici
- Endüstriyel atık sudan fenolün uzaklaştırılması
- Tuvalet ve banyo dezenfeksiyonunda
- Topluma açık tüm mekanların duvar ve tüm yüzeylerinde
- Gıda sterilizasyonunda
- İlaç sanayisinde
- Veteriner grubu
- Tarım grubu
- Medikal (Hastane laboratuvar sterilizasyon) grubu

7.00 USD



YENİ



Ürünün Hazırlanışı

***Uyarı: Ürünün üstüne doğrudan su dökmeyiniz.**

Ürünü önceden hazırlanan suya dökerek kullanınız.

1 paket (5gr) Oxi Granül'ü 2lt su içine ekleyiniz. Yaklaşık 2 dk tamamen çözünene kadar bekleyiniz. Çözünmeyi hızlandırmak için hafifçe çalkalayabilirsiniz. Hazırlanan 2 lt çözeltiye ilave 3 lt daha su ilave ediniz. Toplamda 5 lt uygulamaya hazırdır.



Epoksi Kartuş
Polyester İçerikli
300 ml.

3.70 EURO



20

ISI SEVİYESİNE GÖRE REAKSİYON ZAMANI		
Isı Seviyesi (C°)	Donma Başlangıcı	Donma Sonlanması
40	2 dk.	15 dk.
30	3 dk.	25 dk.
20	4 dk.	45 dk.
5	12 dk.	90 dk.
0	25 dk.	180 dk.
-5	45 dk.	360 dk.

YENİ



Epoksi Kartuş
Polyester İçerikli
345 ml.

3.80 EURO



12

ISI SEVİYESİNE GÖRE REAKSİYON ZAMANI		
Isı Seviyesi (C°)	Donma Başlangıcı	Donma Sonlanması
40	2 dk.	15 dk.
30	3 dk.	25 dk.
20	4 dk.	45 dk.
5	12 dk.	90 dk.
0	25 dk.	180 dk.
-5	45 dk.	360 dk.

YENİ



Epoksi Kartuş
Polyester İçerikli
410 ml.

4.50 EURO



12

ISI SEVİYESİNE GÖRE REAKSİYON ZAMANI		
Isı Seviyesi (C°)	Donma Başlangıcı	Donma Sonlanması
40	2 dk.	15 dk.
30	3 dk.	25 dk.
20	4 dk.	45 dk.
5	12 dk.	90 dk.
0	25 dk.	180 dk.
-5	45 dk.	360 dk.

YENİ



ROX Kamp Ocak Gazı Valfli Kartuş 227 gr

%100 güvenli ve yerli üretim gaz kartuşu
Portatif kamp cihazlarına ve torchlara uygun
Sisleme ilaçlama pompalarına uyumludur.
Dünya standartlarında %30 propan %70 butan karışımı
Her türlü hava koşulunda çalışabilen ucuz pratik enerji kaynağımız

YENİ

2.55 USD



24



ROX Torch Kamp Pürmüz (Eco)

1300°C / 2500°F
Bütan Güç
Pieze Ateşleme
Mavi Alev

8.15 USD



50

YENİ



ROX Torch Kamp Pürmüz (Düz)

1300°C / 2500°F
Bütan Güç
Pieze Ateşleme
Mavi Alev

12.65 USD



50

YENİ



ROX Torch Kamp Pürmüz (Açılı)

1300°C / 2500°F
Bütan Güç
Pieze Ateşleme
Mavi Alev

13.50 USD



50

YENİ



ROX Portatif Kamp Ocağı

30.00 USD



20

YENİ



ROX WOOD
Abs Plastik Üçgen
Marangoz Gönye
175 mm

5.00 USD



ROX WOOD
ABS Açılı Köşe İşkence 175 mm
175x175x30 mm

21.00 USD



ROX WOOD
Alüminyum Üçgen Gönye
175 mm

15.00 USD



ROX WOOD
Alüminyum Üçgen Marangoz Gönye
305 x 430 mm

26.40 USD



ROX WOOD
ABS Gönyeler
200 x 200 x 40 mm

7.90 USD



ROX WOOD
Alüminyum Ayarlı Gönye 300 mm
310x125x35 mm

58.00 USD



ROX WOOD
6 Parça Oyma Seti
Neopren Çanta

38.00 USD



ROX WOOD
4 Parça Iskarpela Seti
Neopren Çanta

30.00 USD



ROX WOOD
Ahşap Oyma Boçağı

4.00 USD



ROX WOOD
13 Parça Neşter Tip
Bıçak Seti

5.50 USD



ROX WOOD
12 Parça Gül Ağacı
Ahşap İşleme
Bıçak Seti

21.00 USD



ROX WOOD
2 Parça Kaşık Oyma ve Bıçak Seti

17.00 USD



ROX WOOD
Kalıplama
250 mm

18.00 USD



ROX WOOD
ABS Açı Bulucu

4.35 USD

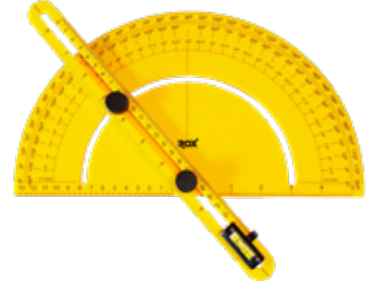

ROX WOOD
Alüminyum
Şablon Cetveli

14.00 USD



ROX WOOD
Alüminyum 3' Köşe Mengene
3'76Mm

5.75 USD



Rox 0069 Hassas Torna Vida Seti
25 Parça
Deri Cüzdan

6.15 USD



Rox Wood 0088 HSS Gravür Makinası
Mini Testere Seti 6 Parça

8.10 USD



ROX WOOD
115 mm Ahşap Oyma Disk
10.000- 13.000 Rpm
Diş sayısı 22
Diş Göbek Çapı 14 mm
Disk çapı 102 mm

14.00 USD



ROX WOOD

Ahşap Yontma Disk

Göbek Çapı 14 mm

Disk Çapı 90 mm

43.30 USD



ROX WOOD

Ahşap Eğe Disk

Göbek Çapı 14 mm

Disk Çapı 85 mm

30.50 USD



ROX WOOD

Manuel Şerit Zımpara Aparatı

32.00 USD



ROX

Kaynak Tutucu Miknastıs

10.00 USD



ROX WOOD

Speed Out 4 Parça Hasarlı Vida Sökücü

4.00 USD



ROX WOOD

150 mm Çelik Pergel

12.00 USD



Ürün uzunluk 150 mm

Kalem tutucusu sayesinde düzgün çizim yapabilirsiniz.

Marangoz atölyeleri ve hobi işlerinizin önemli parçalarından biridir.

ROX WOOD**115'lik Mengeneli Taşlama Tezgahı****27.00 USD**

Rox Wood 113 Avuç Taşlama Tezgahı Sehpası 115-125 mm

Çoğu avuç taşlama makinalarına uygun universal sabitleme sehpası.

Avuç taşlamaların çelik, metal, plastik profil, boru vb. lerinin hassas kesimleri gibi işlemlerde kullanılabilmesini sağlar.

Dayanıklı çelik levha tabanlı, 240x190 mm, 115-125mm disk çaplı avuç taşlamalar için uygundur

Döküm alüminyum destek, dayanıklı döner kol, ve yaylı gevşetme mekanizması

ROX WOOD**40 cm Mengeneli Matkap Tezgahı****41.00 USD**

Rox Wood 114 Ayarlanabilir Mengeneli Matkap Tezgahı Sehpası

43 veya 38mm boyun çaplı matkaplarda kullanmak üzere tasarlanmış

Tek parçadan mamül kolon ve makine mengenesi monte etmek için oyuklu taban

Derinlik ayarlama ölçekli ve durduruculu

Sütun yüksekliği 400 mm

Dügmeli hızlı açılır ve kapanır matkap mengeneside mevcuttur.

ROX WOOD**Alüminyum Mini Sütunlu
Matkap Tezgahı Mengenesi****14.00 USD**

Rox Wood 0094 Alüminyum Mini Sütunlu Matkap Tezgahı Mengenesi

Ayarlanabilir matkap tezgahlarında kullanılır.

Alüminyum Gövde

Hızlı açıp kapama düğmesi

Maksimum çene açıklığı 70 mm

Çene genişliği 70 mm

ROX**Manyetik Parmak Vida Tutucu****3.25 USD**

ROX WOOD

316 Parça Mini Aksesuar Seti

34.50 USD



- | | |
|------------------------------|--|
| 9 Adet Taşlama taşı | 13 Adet Saplı Taş |
| 3 Adet Pens | 1 Adet Bileme Taşı |
| 13 Adet Elmas Freze ucu | 4 Adet Bağlantı Pim Sapı |
| 65 Adet Kesme Taşı | 1 Adet Elmas Kesici Disc |
| 100 Adet Zımpara | 2 Adet Dairesel Deri Honlama |
| 45 Adet Spiro zımpara | 3 Adet Saplı Polisaj Lastik |
| 3 Adet Spiro zımpara aparatı | 2 Adet Saplı Mop Zımpara |
| 14 Adet Parlatma Keçesi | 9 Adet Matkap Ucu |
| 1 Adet Parlatma Macunu | 18 Adet Zımpara Taşı (6 pembe, 6 yeşil, 6 beyaz) |
| 5 Adet Tel Fırça | 1 Adet Anahtar |
| 3 Adet Plastik Telli Fırça | 1 Adet Mini Taşıma Çantası 2 Katlı |



RWL 211

Mini Taşlama Gravür Seti

220 Parça

YENİ

40.00 USD



SFC 300

Mini Taşlama Gravür Seti

300 Parça

Çantalı

YENİ

80.00 USD



ROX WOOD 242 Parça Gravür Seti

Motor gücü: 135 watt
Devir sayısı: 10.000 - 36.000 (ayarlanabilir)
Plastik taşıma çantalı
210 parça aksesuarlı

45.00 USD



ROX WOOD 189 Parça Mini Aksesuar Seti

Dremel, proxxon vb. tüm hobi gravür makinalarında kullanılacak 189 parça aksesuar setidir. Polisaj, zımpara, cila ve kesme işlerinde en çok kullanılan ürünlerden oluşmaktadır.

- | | |
|------------------------------|---|
| 6 Adet Taşlama taşı | 2 Adet Tel Fırça |
| 4 Adet Pens | 1 Adet Plastik Telli Fırça |
| 7 Adet Elmas Freze ucu | 12 Adet Zımpara Taşı (6 pembe, 6 yeşil) |
| 65 Adet Kesme Taşı | 8 Adet Saplı Taş |
| 50 Adet Zımpara | 1 Adet Bileme Taşı |
| 16 Adet Spiro zımpara | 4 Adet Bağlantı Pimi |
| 2 Adet Spiro zımpara aparatı | 2 Adet Dairesel Deri Honlama |
| 7 Adet Parlatma Keçesi | 1 Adet Taşıma Çantası |
| 1 Adet Parlatma Macunu | |



18.00 USD



ROX WOOD 40 Parça Mini Aksesuar Seti

Dremel, proxxon vb tüm hobi gravür makinalarında kullanılacak 40 parça aksesuar setidir. Zımpara ve bileme işlerinde en çok kullanılan ürünlerden oluşmaktadır.

- | |
|--|
| 20 Adet Zımpara |
| 10 Adet Spiro zımpara |
| 1 Adet Spiro zımpara aparatı |
| 4 Adet Zımpara Taşı (2 pembe, 2 yeşil) |
| 4 Adet Saplı Taş |
| 1 Adet Bağlantı Pimi |
| Taşıma Çantası |

6.00 USD



Kimyasal Dübel Çekiş Tip HaC



MODEL	BOYUT		FİYAT
HaC	08 X 80	10 Adet	1.190 EURO
HaC	10 X 80	10 Adet	1.230 EURO
HaC	12 X 110	10 Adet	1.350 EURO
HaC	14 X 125	10 Adet	1.520 EURO
HaC	16 X 125	10 Adet	1.600 EURO
HaC	20 X 175	6 Adet	2.600 EURO
HaC	24 X 210	6 Adet	3.340 EURO
HaC	30 X 265	6 Adet	6.670 EURO

Kimyasal Dübel Normal Tip VDP



MODEL	BOYUT		FİYAT
VDP	08 X 80	10 Adet	0.810 EURO
VDP	10 X 80	10 Adet	0.850 EURO
VDP	12 X 95	10 Adet	0.890 EURO
VDP	14 X 95	10 Adet	1.040 EURO
VDP	16 X 95	10 Adet	1.150 EURO
VDP	20 X 175	6 Adet	2.020 EURO
VDP	24 X 210	6 Adet	2.350 EURO
VDP	30 X 265	6 Adet	5.100 EURO

Kimyasal Rot Altıgen Başlı BH



MODEL	BOYUT		FİYAT
BH	08 X 110	10 Adet	0.419 EURO
BH	10 X 130	10 Adet	0.620 EURO
BH	10 X 190	10 Adet	0.837 EURO
BH	12 X 160	10 Adet	0.997 EURO
BH	12 X 195	10 Adet	1.187 EURO
BH	14 X 190	10 Adet	1.612 EURO
BH	16 X 190	10 Adet	2.041 EURO
BH	16 X 220	10 Adet	2.301 EURO
BH	20 X 260	6 Adet	4.095 EURO
BH	24 X 300	6 Adet	6.903 EURO
BH	30 X 380	6 Adet	16.055 EURO

RED HIT Altıgen Başlı Kimyasal Rot



Fiyat / Adet

8 X 110	0.520 USD
10 X 130	0.650 USD
12 X 160	0.900 USD
14 X 190	1.450 USD
16 X 190	1.850 USD
20 X 260	4.000 USD
22 X 280	5.500 USD
24 X 300	5.700 USD
30 X 380	14.500 USD

Rolwal Boya Karıştırıcı RWL-1636

Güçlü 1300 Watt motor

Tek vites

Elektronik hız ayarı

Optimize edilmiş ergonomik kollar sayesinde kolay çalışma

Yumuşak başlangıç (Soft start) sayesinde sıçrama olmadan başlama

Sıvı ve toz yapı malzemelerinin homojen karışım işleri için özel

olarak geliştirilmiş sağlam ve kullanışlı bir karıştırma makinasıdır.

Güç: 1300 W.

Boşta devir hızı: 0-1600 devir/dakika

Giriş voltajı: 220-240 V. - 50 Hz.

Karıştırıcı girişi: M14

100 mm çaplı karıştırıcı dahil

YENİ

80.00 USD



1300 W.
6 Kademe Devir Ayarlı
Elektrikli Alçı Boya ve Harç
Karıştırıcı Mikser



Daystar Boya Karıştırıcı Uçları

MODEL	BOYUTLAR		FİYAT
SDS Plus karıştırıcı uç	450 x 100 mm.	48	3.50 USD
M 14 karıştırıcı uç	400 x 120 mm.	18	7.00 USD



Boya Karıştırıcı



MODEL	BOYUTLAR		FİYAT
60	400 X 60 mm	50	2.19 USD
120	600 X 120 mm	24	3.15 USD

Profesyonel Boya Karıştırıcıları M14 x 580 mm

EBAT		FİYAT
ø 120 mm	24	8.00 USD



SDS Boya Karıştırıcıları

EBAT		FİYAT
ø 80 mm	48	4.40 USD
ø 100 mm	48	5.00 USD
ø 120 mm	24	6.60 USD

Çelik karıştırma spiral halka
Krom 3 Nikel kaplama
Boya, vernik, alçı gibi malzemelerin karıştırılması için



SDS Lama Boya Karıştırıcıları

EBAT		FİYAT
ø 80 mm	48	3.85 USD
ø 100 mm	48	4.35 USD
ø 120 mm	24	4.90 USD

Çelik karıştırma spiral halka
Krom 3 Nikel kaplama
Boya, vernik, alçı gibi malzemelerin karıştırılması için



ECO Tutkal Karıştırıcıları

EBAT		FİYAT
ø 120 mm	30	6.50 USD



Seramik Kesme Makinaları



MODEL		FİYAT
40 cm.	4	27.50 USD
50 cm.	4	32.00 USD
60 cm.	4	36.80 USD



Seramik Kesme Yedek Elması



MODEL	FİYAT
Seramik Kesme Elması	6.61 USD

Seramik Kesme Makinaları



MODEL	FİYAT
LOTUS 80 cm seramik kesme makinası	170.00 USD
LOTUS 100 cm seramik kesme makinası	198.00 USD
LOTUS 120 cm seramik kesme makinası	231.00 USD

ÇANTA HEDİYELİ



GARDENWIND Bahçe Hortumları

YENİ

MODEL		FİYAT
20 Metre	1	24.00 USD
30 Metre	1	34.00 USD
50 Metre	1	57.00 USD



3 cidarlı
-5C°/50C° hava şartlarına dayanıklı
Çift tekstil örgülü takviyeli
CE Belgeli
UV Filtreli
23 bar patlama basıncı
140 gr/mt
1/2" 13 mm
Thermorubber malzemeden imal

ROX Marine 1/2 Tekne Hortumları

YENİ

MODEL		FİYAT
20 Metre	1	26.50 USD
30 Metre	1	37.50 USD
50 Metre	1	62.50 USD



3 cidarlı
-5C°/50C° hava şartlarına dayanıklı
Çift tekstil örgülü takviyeli
CE Belgeli
UV Filtreli
23 bar patlama basıncı
140 gr/mt
1/2" 13 mm
Thermorubber malzemeden imal

ART 124

Ağır Yük Tipi Çelik Mengene

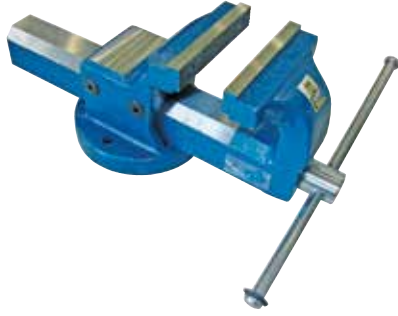

Ölçü	100 mm	125 mm	150 mm
Çene Uzunluğu	100 mm	125 mm	150 mm
Çene Açıklığı	120 mm	160 mm	200 mm
Çene Yüksekliği	65 mm	80 mm	100 mm
Koli Adedi	2	2	1
Fiyat	102.00 USD	168.00 USD	255.00 USD

ART 105

Boru Mengenesi



Ölçü	50 mm	75 mm	100 mm
Koli Adedi	8	4	1
Fiyat	41.00 USD	79.00 USD	265.00 USD

ART 414

Ayaklı Mengene



Ölçü	50 mm
Koli Adedi	2
Fiyat	232.00 USD

SDS Matkap Uçları

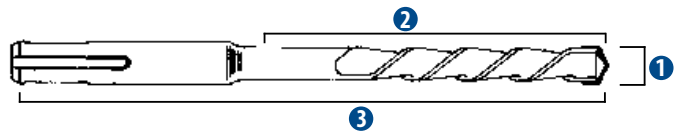

ÜRÜN	1	2	3		FİYAT
4 X 160	4 mm	100 mm	160 mm	40	1.06 USD
6 X 110	6 mm	50 mm	110 mm	40	1.12 USD

80/16 Pnömatik Zimba Tabancası Telleri 6 - 16 mm. Zimbalar

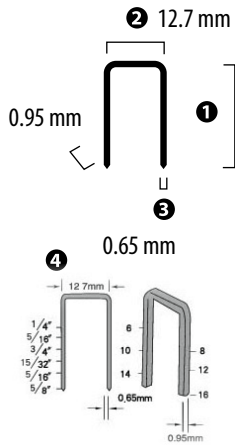

MODEL	BOYUT ①	KUTU		FİYAT
8008 Zimba Teli	8 mm	5.000	150.000 / 30 kutu	kutu:3.35 USD
8010 Zimba Teli	10 mm	4.000	120.000 / 30 kutu	kutu:3.35 USD
8012 Zimba Teli	12 mm	3.000	90.000 / 30 kutu	kutu:3.35 USD
8014 Zimba Teli	14 mm	3.000	90.000 / 30 kutu	kutu:3.35 USD
8016 Zimba Teli	16 mm	2.250	67.500 / 30 kutu	kutu:3.35 USD

F 30 Pnömatik Çivi Çıkma Tabancası 10-50 mm Başlı Çiviler

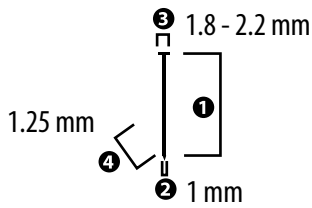

MODEL	BOYUT ①	KUTU		FİYAT
F 10	10 mm	5000	100000 / 20 kutu	kutu:2.90 USD
F 15	15 mm	5000	100000 / 20 kutu	kutu:4.00 USD
F 20	20 mm	5000	100000 / 20 kutu	kutu:4.97 USD
F 25	25 mm	5000	100000 / 20 kutu	kutu:6.20 USD
F 28	28 mm	5000	100000 / 20 kutu	kutu:6.95 USD
F 30	30 mm	5000	100000 / 20 kutu	kutu:7.95 USD
F 40	40 mm	5000	100000 / 20 kutu	kutu:9.90 USD
F 50	50 mm	5000	100000 / 20 kutu	kutu:12.95 USD

Gaz Tankı

500'lük kısa ve 1000'lik uzun iki tür gaz deposu ile kullanım imkanı

Haznesine 4 şerit (40 adet) çivi alma kapasitesi Çelik sacda ve sert betonda kullanım imkanı



REDHIT Gaz Tankı 1000 atımlık

21.00 USD

ESNEK TİP BEYAZ ÇİVİLER (Fiyatlar 1000 adet çivi içindir)	FİYAT
1000 adet GZT-19	61.60 USD
1000 adet GZT-25	66.00 USD
1000 adet GZT-32	72.60 USD
1000 adet GZT-38	90.20 USD



RED HIT TABANCA UYUMLU SİYAH ÇİVİLER (Fiyatlar 1000 adet çivi içindir)	FİYAT
1000 adet SC6/15	48.50 USD
1000 adet SC6/20	50.50 USD
1000 adet SC6/25	52.80 USD
1000 adet SC6/30	55.80 USD
1000 adet SC6/35	59.00 USD
1000 adet SC6/40	66.50 USD



Çivi Çakma Tabancası AX 4500



Allen anahtarı, yağdanlık, namlu fırçası, tel fırça ve tornavidalı set.

440.00 USD



NK tipi pullu çelik çivilerle kullanılır. 27 kalibre kapsüller kullanılır. Zemin sertliğine göre farklı renklerde kapsül kullanılır. Ahşap, beton, çelik yüzeylere uygundur. Ahşap ve çelik betona, çelik çeliğe uygulama yapılabilir.

AX 4500 Çakma Tabancası Kapsülleri

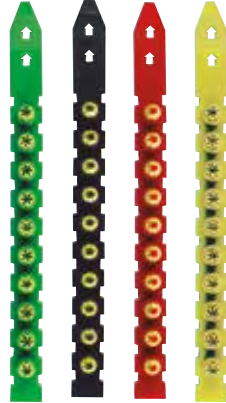

27 Kalibre, 6.8 x 11 mm.
4 ayrı renkte.
Sarı, kırmızı,
siyah ve yeşil.

100 lük kutularda
1.000 lik paketlerde

0.070 USD



NK DX-450 Çelik Çiviler

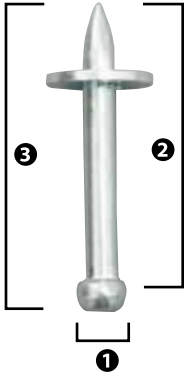

NK tipi çelik çiviler çinko kaplama 12 mm. çelik pullu AX 4500, DX 450 - DX 350 tabancaları ile uyumludur.

MODEL	①	②	③	FİYAT
NK 22	5.5 mm	22 mm	25 mm	0.039 USD
NK 27	5.5 mm	27 mm	30 mm	0.042 USD
NK 32	5.5 mm	32 mm	35 mm	0.045 USD
NK 37	5.5 mm	37 mm	40 mm	0.048 USD
NK 42	5.5 mm	42 mm	45 mm	0.055 USD
NK 47	5.5 mm	47 mm	50 mm	0.059 USD
NK 54	5.5 mm	54 mm	57 mm	0.064 USD
NK 62	5.5 mm	62 mm	65 mm	0.072 USD
NK 72	5.5 mm	72 mm	75 mm	0.087 USD
NK 82	5.5 mm	82 mm	85 mm	0.106 USD
NK 92	5.5 mm	92 mm	95 mm	0.151 USD
NK102	5.5 mm	100 mm	103 mm	0.170 USD

100 lük kutularda  3.000

Sac Gömlekleli Dübel

Beton kalitesinin yüksek olmadığı alanlarda kullanılan galvaniz kaplı çelik dübel



	Plastikap / Adet	Koli / Adet	Fiyat / Adet
M6 x 08 X 65	400	800	0.129 USD
M8 x 10 X 55	300	600	0.170 USD
M8 x 10 X 75	200	400	0.219 USD
M10 x 12 X 70	150	300	0.319 USD
M10 x 12 X 85	120	240	0.352 USD
M10 x 12 X 110	100	200	0.453 USD
M12 x 16 X 90	75	150	0.660 USD
M12 x 16 X 110	60	120	0.797 USD

Borulu Dübel

Beton kalitesinin yüksek olmadığı alanlarda özellikle asansör ray montajında kullanılan galvaniz kaplı çelik dübel



	Plastikap / Adet	Koli / Adet	Fiyat / Adet
M8 x 13 x 75	150	300	0.340 USD
M10 x 15 x 85	100	200	0.480 USD
M10 x 15 x 110	80	160	0.660 USD
M12 x 16 x 90	50	100	0.682 USD
M12 x 16 x 110	50	100	0.820 USD
M16 x 22 x 120	30	60	1.925 USD
M20 x 25 x 140	15	30	3.767 USD

Gömlekleli Dübel

Beton kalitesinin yüksek olmadığı alanlarda kullanılan somun başlı güvenli ağır yük dübeli



MODEL			FİYAT
12 C M10 x 70	25	250	0.187 USD
14 C M10 x 70	25	125	0.225 USD

Asma Tavan Dübeli

Asma tavan uygulamalarında hızlı montaj imkanı sağlayan galvaniz kaplı çelik dübel





	Plastikap / Adet	Koli / Adet	Fiyat / Adet
M6 X 8 X 45	350	700	0.118 USD

Çakmalı Dübel

Gijon ile tespit imkanı sağlayan, karot makinası ve iskele montajında kullanılabilen galvaniz kaplı dübel





MODEL			FİYAT
M6 20 mm.	100	2000	0.092 USD
M8 30 mm.	100	2000	0.095 USD
M10 40 mm.	50	1000	0.162 USD
M12 50 mm.	50	500	0.342 USD
M14 55 mm.	50	500	0.676 USD
M16 65 mm.	25	250	0.735 USD
M20 80 mm.	20	120	2.170 USD

Çekmeli Dübel

Yan tarafı tırnaklı beton içinde dönmeyi engelleyen plastik tapalı, çekme kuvveti yüksek galvaniz kaplı çelik dübel





MODEL			FİYAT
M8 x 50	100	1800	0.173 USD
M10 x 60	80	960	0.272 USD
M12 x 75	40	640	0.431 USD

Kancalı Dübel

Gömleklili dübel ile aynı özelliklerde asma amaçlı ağır yük dübeli





MODEL			FİYAT
H6 x 45	100	400	0.250 USD
H8 x 60	50	200	0.430 USD
H10 x 70	50	100	0.670 USD
H10 x 90	50	100	0.830 USD

Kapalı Kancalı Dübel

U-Bolt dübel, gömleklili dübel ile aynı özelliklerde asma amaçlı kapalı kancalı ağır yük dübeli





MODEL			FİYAT
E6 x 45	100	400	0.280 USD
E8 x 60	50	200	0.450 USD
E10 x 70	50	100	0.710 USD
E10 x 90	50	100	0.830 USD

Klipsli Dübel

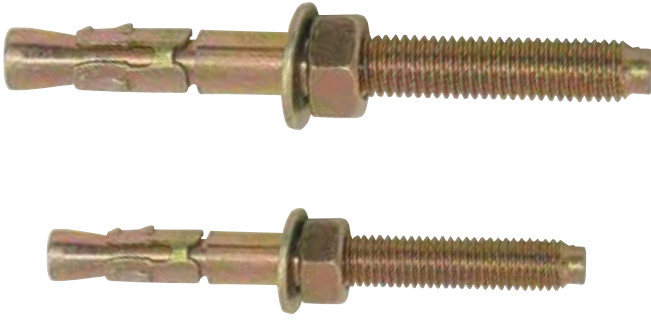
Asma yüklerinde, bağlantı kanallarında, köşebent montajlarında pratiklik sağlayan galvaniz kaplı çelik dübel



MODEL			FİYAT
M8 X 75	100	500	0.250 USD
M8 X 100	100	500	0.290 USD
M10 X 90	50	500	0.350 USD
M10 X 110	50	500	0.400 USD
M10 X 120	50	500	0.420 USD
M10 X 160	25	250	0.520 USD
M10 X 200	25	250	0.530 USD
M12 X 90	25	125	0.500 USD
M12 X 110	25	125	0.520 USD
M12 X 150	25	125	0.740 USD
M12 X 200	25	125	0.800 USD
M16 X 145	20	100	1.200 USD
M16 X 180	20	100	2.350 USD
M20 X 180	10	50	2.550 USD

Çektirme Dübel

Yan tarafı tırnaklı beton içinde dönmeyi engelleyen plastik tapalı, civata ve pullu, güvenli ağır yük dübeli





MODEL			FİYAT
M12 X 100	25	160	0.320 USD

Ağır Yük Dübeli

Yüksek direnç uygulamalarında kolaylık sağlayan dübel





MODEL			FİYAT
M10 X 14 X 125	25	100	1.610 USD
M12 X 18 X 130	20	80	2.300 USD
M16 X 24 X 140	10	40	4.210 USD
M20 X 28 X 200	5	20	8.500 USD

Turbolet Plastik Sivri Uçlu Dübel

Alçıpan uygulamalarında kolaylık sağlayan plastik dübel





MODEL			FİYAT
30 mm	500	10.000	0.033 USD

Turbolet Plastik Küt Uçlu Dübel

Alçıpan uygulamalarında kolaylık sağlayan plastik dübel





MODEL			FİYAT
30 mm	1000	10.000	0.033 USD

Turbolet Metal Dübel

Alçıpan uygulamalarında kolaylık sağlayan metal dübel



MODEL			FİYAT
30 mm	1000	10.000	0.097 USD

Gaz Beton Dübeli

Ytong uygulamalarında kullanılan dübel



MODEL		FİYAT
8 mm	1000	0.085 USD
10 mm	1000	0.085 USD

Alçıpan Dübeller

Toks tipi plastik alçıpan dübelleri





MODEL		FİYAT
J-8	1000	0.030 USD
J-10	500	0.042 USD

Plastik Duvar Dübeli

Her türlü kapı pencere kasalarının sabitlenmesini sağlayan plastik dübel





MODEL			FİYAT
M4 X 20	500	24,000	0.005 USD
M5 X 25	300	14,400	0.006 USD
M6 X 30	100	4,800	0.007 USD
M7 X 30	100	4,800	0.010 USD
M8 X 40	100	3,000	0.012 USD
M10 X 50	50	1,500	0.021 USD
M12 X 60	25	750	0.032 USD
M14 X 75	20	600	0.054 USD

Nylon Plug Kasa Dübeli

Her türlü kapı, pencere kasalarının sabitlenmesini sağlayan plastik dübel



MODEL			FİYAT
M6 X 40	100	1600	0.115 USD
M6 X 60	100	1600	0.145 USD
M8 X 60	100	1000	0.165 USD
M8 X 80	100	800	0.190 USD
M8 X 100	100	800	0.230 USD
M8 X 120	100	800	0.240 USD
M8 X 140	100	800	0.380 USD
M10 X 100	50	450	0.500 USD
M10 X 140	50	450	0.520 USD
M10 X 160	50	450	0.650 USD

Kanatlı Alçıpan Dübeli

Alçıpan ve boşluk yüzeylerde uygulanabilen kanatlı tip dübel



MODEL		FİYAT
2 mm.	500	0.031 USD
3 mm.	250	0.033 USD

Akülü Matkap CD 5804

16.8 V. 1.5 Amper
Yüksüz hız: 1 vites 0-350 devir/dakika
Yüksüz hız: 2 vites 0-1350 devir/dakika
Max. tork: 25 Nm
Tork: 18+1

YENİ**63.00 USD**

13 mm Darbeli Matkap ID 7133

600 Watt
Mandren: 13 mm
Çalışma Voltajı: 220 V.
Yüksüz hız: 0-3300 devir/dakika
Led lambalı

YENİ**33.00 USD**

SDS Plus Kırıcı Delici HF 2601

900 Watt
Mandren: 13 mm
Çalışma Voltajı: 220 V.
Yüksüz hız: 0-13000 devir/dakika
Plastik taşıma çantalı
Aksesuarlı

YENİ**72.00 USD**

Avuç Taşlama AG 5152

620 Watt
Çalışma Voltajı: 220 V.
Yüksüz hız: 13000 devir/dakika
Disk çapı:115 mm

YENİ**29.50 USD**

Polisaj Makinası DP 3851

1300 Watt
Çalışma Voltajı: 220 V.
Yüksüz hız: 1000-3000 devir/dakika
Disk çapı:180 mm

YENİ**66.00 USD**

Manyetik Matkap MA Basic 35

1050 Watt
230 V. AC 50 Hz.
İniş kalkış yüksekliği: 160 mm
Manyeto ebatları: 84 x 168 x 41.5 mm
Ağırlık: 12 kg
12 mm. - 35 mm. delik açma kapasitesi
Taşıma çantası
Emniyet gözlüğü
Eldiven
Bağlama kayışı
Fırlatma pimi
Allen anahtarları İngiliz

YENİ

695.00 EURO



HSS-Standart Manyetik Matkap Uçları - Kısa 30 mm delme derinliği 19 mm Weldon Shank (3/4")

MODEL	ÇAP	FİYAT
KBK 012	12 mm	16.80 EURO
KBK 013	13 mm	16.50 EURO
KBK 014	14 mm	16.00 EURO
KBK 015	15 mm	18.80 EURO
KBK 016	16 mm	19.00 EURO
KBK 017	17 mm	19.80 EURO
KBK 175	17,5 mm	20.30 EURO
KBK 018	18 mm	18.80 EURO
KBK 019	19 mm	20.80 EURO
KBK 195	19,5 mm	22.30 EURO
KBK 020	20 mm	21.80 EURO
KBK 021	21 mm	23.30 EURO
KBK 022	22 mm	22.80 EURO
KBK 023	23 mm	25.00 EURO
KBK 024	24 mm	25.80 EURO
KBK 025	25 mm	26.50 EURO
KBK 026	26 mm	26.00 EURO
KBK 027	27 mm	28.50 EURO
KBK 028	28 mm	29.50 EURO
KBK 029	29 mm	30.30 EURO
KBK 030	30 mm	31.30 EURO
KBK 031	31 mm	31.00 EURO
KBK 032	32 mm	32.80 EURO
KBK 033	33 mm	34.80 EURO
KBK 034	34 mm	40.80 EURO
KBK 035	35 mm	44.80 EURO

MODEL	ÇAP	FİYAT
KBK 036	36 mm	47.80 EURO
KBK 037	37 mm	48.50 EURO
KBK 038	38 mm	48.30 EURO
KBK 039	39 mm	50.50 EURO
KBK 040	40 mm	52.00 EURO
KBK 041	41 mm	58.30 EURO
KBK 042	42 mm	61.00 EURO
KBK 043	43 mm	63.30 EURO
KBK 044	44 mm	67.30 EURO
KBK 045	45 mm	68.80 EURO
KBK 046	46 mm	70.80 EURO
KBK 047	47 mm	73.00 EURO
KBK 048	48 mm	74.50 EURO
KBK 049	49 mm	76.80 EURO
KBK 050	50 mm	79.30 EURO
KBK 051	51 mm	84.80 EURO
KBK 052	52 mm	88.80 EURO
KBK 053	53 mm	100.00 EURO
KBK 054	54 mm	101.80 EURO
KBK 055	55 mm	105.50 EURO
KBK 056	56 mm	109.80 EURO
KBK 057	57 mm	112.00 EURO
KBK 058	58 mm	115.30 EURO
KBK 059	59 mm	117.50 EURO
KBK 060	60 mm	120.30 EURO

HSS-Standart Manyetik Matkap Uçları - Uzun 55 mm delme derinliği 19 mm Weldon Shank (3/4")

MODEL	ÇAP	FİYAT
KBL 012	12 mm	22.50 EURO
KBL 013	13 mm	23.30 EURO
KBL 014	14 mm	21.30 EURO
KBL 015	15 mm	24.50 EURO
KBL 016	16 mm	26.30 EURO
KBL 017	17 mm	27.30 EURO
KBL 175	17,5 mm	29.50 EURO
KBL 018	18 mm	26.00 EURO
KBL 019	19 mm	31.00 EURO
KBL 195	19,5 mm	33.50 EURO
KBL 020	20 mm	32.30 EURO
KBL 021	21 mm	33.00 EURO
KBL 022	22 mm	33.00 EURO
KBL 023	23 mm	35.80 EURO
KBL 024	24 mm	37.30 EURO
KBL 025	25 mm	38.00 EURO
KBL 026	26 mm	38.50 EURO
KBL 027	27 mm	41.80 EURO
KBL 028	28 mm	43.00 EURO
KBL 029	29 mm	44.30 EURO
KBL 030	30 mm	45.50 EURO
KBL 031	31 mm	47.50 EURO
KBL 032	32 mm	48.50 EURO
KBL 033	33 mm	49.50 EURO
KBL 034	34 mm	50.80 EURO
KBL 035	35 mm	52.50 EURO

MODEL	ÇAP	FİYAT
KBL 036	36 mm	56.50 EURO
KBL 037	37 mm	57.30 EURO
KBL 038	38 mm	59.30 EURO
KBL 039	39 mm	60.50 EURO
KBL 040	40 mm	61.80 EURO
KBL 041	41 mm	67.50 EURO
KBL 042	42 mm	68.80 EURO
KBL 043	43 mm	70.50 EURO
KBL 044	44 mm	72.30 EURO
KBL 045	45 mm	74.80 EURO
KBL 046	46 mm	77.50 EURO
KBL 047	47 mm	81.30 EURO
KBL 048	48 mm	82.80 EURO
KBL 049	49 mm	85.00 EURO
KBL 050	50 mm	87.30 EURO
KBL 051	51 mm	98.30 EURO
KBL 052	52 mm	107.00 EURO
KBL 053	53 mm	111.80 EURO
KBL 054	54 mm	116.00 EURO
KBL 055	55 mm	120.00 EURO
KBL 056	56 mm	123.80 EURO
KBL 057	57 mm	127.30 EURO
KBL 058	58 mm	131.30 EURO
KBL 059	59 mm	135.80 EURO
KBL 060	60 mm	139.30 EURO

RAPİD R 13 HOBİ VE EV UYGULAMALARI İÇİN ZIMBA TABANCASI

28.50 USD



10

4-10 MM NO 13 YUVARLAK ZIMBA TELİ
GÜRÜLTÜ AZALTICI GERİ TEPMESİZ

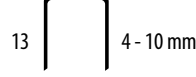

RAPİD R 23 PROFESYONEL KULLANICILARIN YÜKSEK BEKLENTİLERİNİ KARŞILAYAN DAYANIKLILIĞI YÜKSEK TAMAMEN ÇELİK ZIMBA TABANCASI

43.50 USD



5

4-8 MM NO 13 YUVARLAK ZIMBA TELİ
KASA VE MEKANİK PARÇALAR TAMAMEN ÇELİKTİR



RAPİD R 33 DAYANIKLI TAMAMEN ÇELİK ZIMBA TABANCASI

56.00 USD



5

6-14 MM NO 13 YUVARLAK ZIMBA TELİ
KASA MEKANİK, PARÇALAR ÇELİKTİR
AYARLANABİLİR GÜÇ

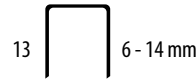

RAPİD R 34 DAYANIKLI TAMAMEN ÇELİK ZIMBA TABANCASI

56.00 USD



3

6-14 MM NO 140 ZIMBA TELİ ÇAKMA TABANCASI
KASA MEKANİK, PARÇALAR ÇELİKTİR
AYARLANABİLİR GÜÇ



RAPİD R 353 MEKANİK ZIMBA TABANCASI

57.00 USD



3

6-14 MM NO 53 U TİPİ ZIMBA TELİ
GÜRÜLTÜ AZALTICI
GERİ TEPMESİZ



RAPİD PS 141 PNOMATİK ZIMBA TABANCASI (6-16 mm)

RED HIT 8016 zimba telleri serisi ile uyumludur.

137.00 USD



RAPİD PB 131 PNOMATİK ÇİVİ ÇAKMA TABANCASI (15-50 mm)

165.00 USD



RAPİD PBS 151 PNOMATİK ÇİVİ VE ZIMBA ÇAKMA TABANCASI (15-50 / 20 - 40 mm)

194.00 USD

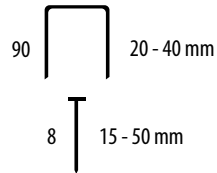

RAPİD EN 330 ELEKTRİKLİ ÇİVİ TABANCASI

150.00 USD

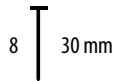

RAPİD BTX 530 KABLOSUZ TABANCA (ŞARJLI)

205.00 USD

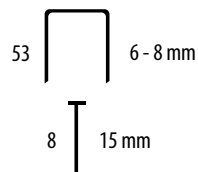

RAPİD R 553 ELEKTRİKLİ ZIMBA ÇAKMA TABANCASI UYUMLU ZİMBALAR (53 SERİSİ)

299.00 USD

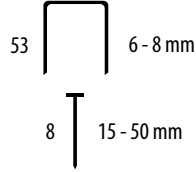

RAPİD PMP 171 BAŞSIZ ÇİVİ ÇAKMA TABANCASI

177.00 USD



RAPİD RP 03 KEMER - DERİ DELME PENSİ

22.50 USD



RAPİD RP 05 KUŞ GÖZÜ PENS

32.00 USD



RAPİD EG POINT
SICAK SİLİKON TABANCASI (7 mm. İnce)
80 W.

27.75 USD



RAPİD HOBBY D 1277
SICAK SİLİKON TABANCASI (12 mm. Kalın)
72 W.

33.00 USD



RAPİD EG 212
SICAK SİLİKON TABANCASI (12 mm. Kalın)
200 W.

40.00 USD



RAPİD CG 270
SICAK SİLİKON TABANCASI (12 mm. Kalın)
250 W.

57.00 USD



RAPİD EG 310
SICAK SİLİKON TABANCASI (12 mm. Kalın)
250 W.

160.00 USD



RAPİD EG 320
SICAK SİLİKON TABANCASI
120 W.

177.00 USD



RAPİD BGX7
PİLLİ SİLİKON TABANCASI
3,6 V.

105.00 USD



RAPİD EG 340
SICAK SİLİKON TABANCASI
220 W.

433.00 USD



RAPİD BGX 300
ŞARJLI SICAK SİLİKON TABANCASI
30 W.

245.00 USD



RAPİD RP 10 PERÇİN PENSİ

46.00 USD



5

3.2, 4.0, 4.8 mm perçin

100 Adet perçin dahil



RAPİD RP 40 ÇOK AMAÇLI PERÇİN ALETİ

70.00 USD



5

3.2, 4.0, 4.8 mm perçin



RAPİD RP 60 DÖNER BAŞLI PERÇİN ALETİ

70.00 USD



5

3.2, 4.0, 4.8 mm perçin



RAPİD RP 100 AĞIR İŞ PERÇİN ALETİ

75.00 USD



5

3.2, 4.0, 4.8 mm perçin



MÜŞTERİ TEMSİLCİLERİMİZ

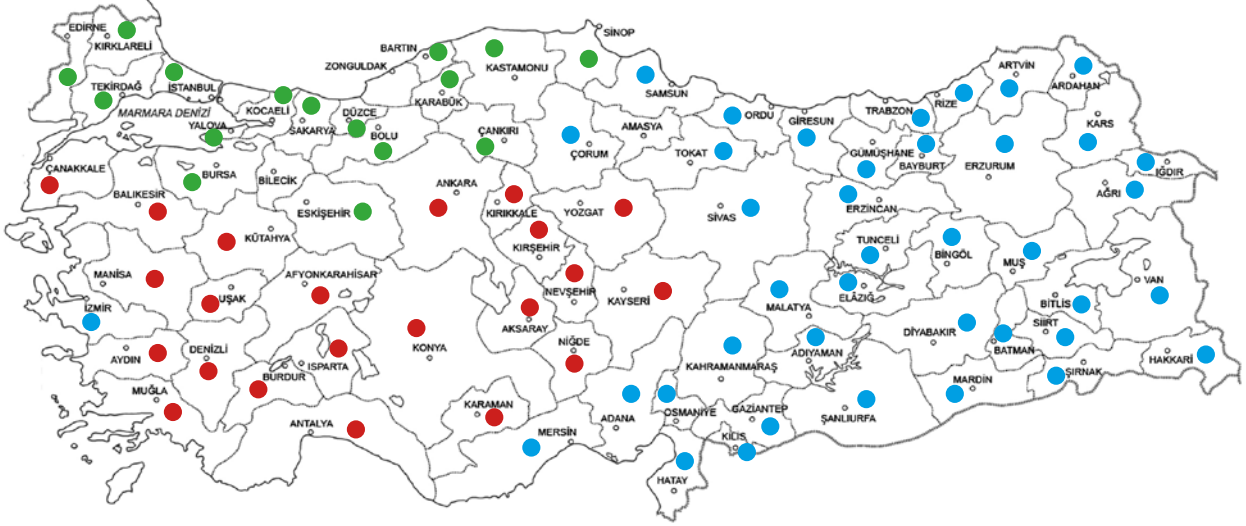

Niso Varon	0533 290 72 64
● Yusuf Beşirli	0538 922 28 83
● Fatih Yıldız	0533 453 36 39
● Levent Temür	0531 936 23 48